

SIEMENS



www.siemens.com/medium-voltage-switchgear

Switchgear Type 8DJH for Secondary Distribution Systems up to 24 kV, Gas-Insulated

Medium-Voltage Switchgear · Catalog HA 40.2 · 2014

Answers for infrastructure and cities.

R-HA40-109.eps



R-HA40-110.eps



R-HA40-112.eps

R-HA40-111.eps



Switchgear Type 8DJH for Secondary Distribution Systems up to 24 kV, Gas-Insulated

Medium-Voltage Switchgear

Catalog HA 40.2 · 2014

Invalid: Catalog HA 40.2 · 2012

www.siemens.com/medium-voltage-switchgear

Application, requirements	Page
Types, typical uses, ratings, approvals	4 and 5
Features, safety, technology, classification	6 to 8
Technical Data	
Electrical data	9
Switching capacity and classification of switching devices	10 and 11
Product Range	
Individual panels and modules	12 to 14
Air-insulated billing metering panels	15
Preferred scheme versions	16 and 17
Design	
Panel design	18 to 21
Outdoor enclosure	22
Operation	23
Components	
Three-position switch-disconnector	24 to 26
Vacuum circuit-breaker	27 to 29
Busbar extension	30
HV HRC fuse assembly	31 to 36
Current and voltage transformers	37 to 41
Intelligent current and voltage sensors	42 and 43
Cable connections, cable plugs	44 to 50
Interlocks, locking devices	51
Indicating and measuring equipment	52 to 60
Transformer monitoring	61
Intelligent transformer substation	62 and 63
Protection systems	64
Low-voltage compartment, low-voltage niche	65
Dimensions	
Room planning, switchgear installation	66 to 68
Individual panels and modules, panel combinations	69 to 81
Outdoor enclosure	82
Floor openings and fixing points	83 to 86
Installation	
Shipping data, transport	87 and 88
Standards	
Standards, specifications, guidelines	89 to 91



The products and systems described in this catalog are manufactured and sold according to a certified management system (acc. to ISO 9001, ISO 14001 and BS OHSAS 18001).

Application

Types



R-HA40-149.eps

Individual circuit-breaker panel 500 mm



R-HA40-150.eps

RRT block

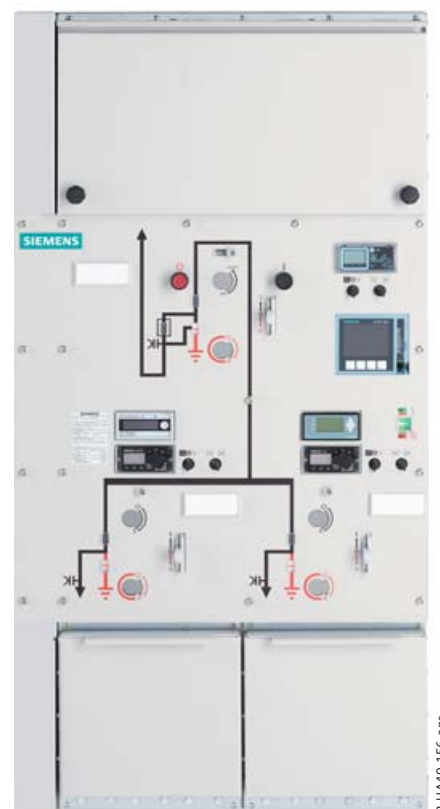

R-HA40-156.eps

8DJH Compact RRT block

8DJH switchgear is a factory-assembled, type-tested, 3-pole metal-enclosed single-busbar switchgear for indoor installation.

8DJH switchgear is used in public and industrial energy systems of the secondary distribution level, e.g. in

- Local ring-main units, customer transfer substations and switching substations of power supply and public utilities
- Wind power and solar plants, hydroelectric power plants
- Water and sewage treatment plants
- Airports, railway stations, underground railway stations
- Open-cast mining facilities
- High-rise buildings.

Electrical data (maximum values) and dimensions

Rated voltage	kV	7.2	12	15	17.5	24
Rated frequency	Hz	50/60	50/60	50/60	50/60	50/60
Rated short-duration power-frequency withstand voltage	kV	20 ¹⁾	28 ²⁾	36	38	50
Rated lightning impulse withstand voltage	kV	60 ¹⁾	75 ²⁾	95	95	125
Rated peak withstand current	kA	63	63	63	63	50
Rated short-circuit making current	kA	63	63	63	63	50
Rated short-time withstand current 3 s	kA	20	20	20	20	20
Rated short-time withstand current 1 s	kA	25	25	25	25	20
Rated normal current of the busbar	A	630	630	630	630	630
Rated normal current of feeders	A	200/250/400/630 ³⁾	→			
Width (feeders)	mm	310/430/500 ³⁾	→			
Depth						
– without pressure relief duct	mm	775	775	775	775	775
– with pressure relief duct	mm	890	890	890	890	890
Height without low-voltage compartment and pressure relief duct	mm	optionally 1040/1200/1400/1700				

1) 32 kV / 60 kV according to some national requirements

2) 42 kV / 75 kV according to some national requirements

3) Depending on the feeder function and the selected design options

National approval GOST

By certification in the system GOST R in Russia, 8DJH is approved for application at the voltage levels 6 kV, 10 kV and 20 kV. The relevant certification documents are available on the Internet at www.siemens.com/8DJH. The approval is valid in the countries Russia, Belarus, Kazakhstan and Ukraine.



Requirements

Features

Environmental independence

Hermetically tight, welded switchgear vessels made of stainless steel as well as single-pole solid insulation make the parts of the primary circuit under high voltage of 8DJH switchgear

- Insensitive to certain aggressive ambient conditions, such as:
 - Saline air
 - Air humidity
 - Dust
 - Condensation
- Tight to ingress of foreign objects, such as:
 - Dust
 - Pollution
 - Small animals
 - Humidity.

Compact design

Thanks to the use of SF₆ insulation, compact dimensions are possible.

Thus:

- Existing switchgear rooms and substation rooms can be used effectively
- New constructions cost little
- Costly city-area space is saved.

Maintenance-free design

Switchgear vessels designed as sealed pressure systems, maintenance-free switching devices and enclosed cable plugs ensure:

- Maximum supply reliability
- Personnel safety
- Sealed-for-life design according to IEC 62271-200 (sealed pressure system)
- Installation, operation, extension and replacement without SF₆ gas work
- Reduced operating costs
- Cost-efficient investment
- No maintenance cycles.

Innovation

The use of digital secondary systems and combined protection and control devices ensures:

- Clear integration in process control systems
- Flexible and highly simplified adaptation to new system conditions and thus cost-efficient operation.

Service life

Under normal operating conditions, the expected service life of gas-insulated switchgear 8DJH is at least 35 years, probably 40 to 50 years, taking the tightness of the hermetically welded switchgear vessel into account. The service life is limited by the maximum number of operating cycles of the switchgear devices installed:

- For circuit-breakers, according to the endurance class defined in IEC 62271-100
- For three-position disconnectors and earthing switches, according to the endurance class defined in IEC 62271-102
- For three-position switch-disconnectors and earthing switches, according to the endurance class defined in IEC 62271-103.

Safety

Personal safety

- Safe-to-touch and hermetically sealed primary enclosure
- Standard degree of protection IP 65 for all high-voltage parts of the primary circuit, at least IP 2X for the switchgear enclosure according to IEC 60529 and VDE 0470-1
- Cable terminations, busbars and voltage transformers are surrounded by earthed layers. All high-voltage parts including the cable terminations, busbars and voltage transformers are metal-enclosed
- Operating mechanisms and auxiliary switches safely accessible outside the primary enclosure (switchgear vessel)
- High resistance to internal arcs by logical mechanical interlocks and tested switchgear enclosure
- Panels tested for resistance to internal faults up to 21 kA
- Capacitive voltage detecting system to verify safe isolation from supply
- Due to the system design, operation is only possible with closed switchgear enclosure
- Logical mechanical interlocks prevent maloperation
- HV HRC fuses and cable sealing ends are only accessible when outgoing feeders are earthed
- Feeder earthing via make-proof earthing switches.

Security of operation

- Hermetically sealed primary enclosure independent of environmental effects (pollution, humidity and small animals)
- Welded switchgear vessels, sealed for life
- Maintenance-free in an indoor environment (IEC 62271-1 and VDE 0671-1)
- Operating mechanisms of switching devices accessible outside the primary enclosure (switchgear vessel)
- Metal-coated, plug-in inductive voltage transformers mounted outside the SF₆ switchgear vessel
- Current transformers as ring-core current transformers mounted outside the SF₆ switchgear vessel
- Complete switchgear interlocking system with logical mechanical interlocks
- Mechanical position indicators integrated in the mimic diagram
- Minimum fire load
- Option: Resistance against earthquakes.

Reliability

- Type and routine-tested
- Standardized and manufactured using numerically controlled machines
- Quality assurance in accordance with DIN EN ISO 9001
- More than 500,000 switchgear panels of Siemens in operation worldwide for many years.

General

- Three-pole primary enclosure, metal-enclosed
- Welded switchgear vessel without seals, made of stainless steel, with welded-in bushings for electrical connections and mechanical components
- Insulating gas SF₆
- Maintenance-free components under normal ambient conditions according to IEC 62271-1 and VDE 0671-1
- Three-position switch-disconnector with load-break function and make-proof earthing function
- Vacuum circuit-breaker
- Cable connection with outside-cone plug-in system
 - In ring-main and circuit-breaker feeders with bolted contact (M16)
 - In transformer feeders with plug-in contact or optionally with bolted contact (M16)
- Wall-standing or free-standing arrangement
- Pressure relief downwards, optionally to the rear or upwards via pressure absorber systems.

Interlocks

- According to IEC 62271-200 and VDE 0671-200
- Logical mechanical interlocks prevent maloperation
- Logical mechanical interlocks and the constructive features of the three-position switches prevent maloperation as well as access to the cable connection of the feeders and HV HRC fuses under voltage
- Impermissible and undesired operations can be prevented by means of locking devices provided at the switching devices
- A detailed description of all interlocking options is available on page 51.

Modular design

- Individual panels and panel blocks can be lined up and extended at will – without gas work on site
- Low-voltage compartment available in 4 overall heights, wiring to the panel via plug connectors.

Instrument transformers

- Current transformers not subjected to dielectric stress
- Easy replacement of current transformers designed as ring-core transformers
- Metal-coated, plug-in voltage transformers.

Vacuum circuit-breaker

- Maintenance-free under normal ambient conditions according to IEC 62271-1 and VDE 0671-1
- No relubrication or readjustment
- Up to 10,000 operating cycles
- Vacuum-tight for life.

Secondary systems

- Customary protection, measuring and control equipment
- Option: Numerical multifunction protection relay with integrated protection, control, communication, operating and monitoring functions
- Can be integrated in process control systems.

Requirements

Classification

8DJH switchgear is classified according to IEC/EN 62271-200/VDE 0671-200.

Design and construction

Partition class	PM (partition of metal)
Loss of service continuity category for panels or panel blocks <ul style="list-style-type: none"> – With HV HRC fuses (T, H) – Without HV HRC fuses (R, L, ...) 	LSC 2 LSC 2
Billing metering panel M Cable panel K	LSC 1
Accessibility to compartments (enclosure) <ul style="list-style-type: none"> – Busbar compartment – Switching-device compartment – Low-voltage compartment (option) – Cable compartment for panels or panel blocks <ul style="list-style-type: none"> – With HV HRC fuses (T) – Without HV HRC fuses (R, L, ...) – Only cable feeder (K) – Metering panels (air-insulated) (M) 	<ul style="list-style-type: none"> – Non-accessible – Non-accessible – Tool-based – Interlock-controlled – Interlock-controlled – Tool-based – Tool-based

Internal arc classification (option)

Designation of the internal arc classification IAC IAC class for 8DJH Standard and 8DJH Compact design for <ul style="list-style-type: none"> – Wall-standing arrangement – Free-standing arrangement 	Rated voltage 7.2 kV to 24 kV IAC A FL IAC A FLR
Additionally only for 8DJH Compact design for <ul style="list-style-type: none"> – Installation in substations without control aisle ¹⁾ 	IAC A F
Type of accessibility A <ul style="list-style-type: none"> – F – L – R 	Switchgear in closed electrical service location, access “for authorized personnel only” (according to IEC/EN 62271-200) Front Lateral Rear (for free-standing arrangement)
Arc test current	Up to 21 kA
Test duration	1 s

1) Rear space required for pressure relief.

Application recommended in prefabricated substations without control aisle, tested according to IEC 62271-202.

Rated insulation level		Rated voltage U_r	kV	7.2	12	15	17.5	24	
		Rated short-duration power-frequency withstand voltage U_d							
		– Phase-to-phase, phase-to-earth, open contact gap	kV	20	28/42 ¹⁾	36	38	50	
		– Across the isolating distance	kV	23	32/48 ¹⁾	39	45	60	
		Rated lightning impulse withstand voltage U_p							
		– Phase-to-phase, phase-to-earth, open contact gap	kV	60	75	95	95	125	
		– Across the isolating distance	kV	70	85	110	110	145	
Rated frequency f_r			Hz	50/60					
Rated normal current I_r ²⁾		for ring-main feeders	A	400 or 630					
		for busbar	A	630					
		for circuit-breaker feeders	A	250 or 630					
		for transformer feeders	A	200 ³⁾					
50 Hz	Rated short-time withstand current I_k	for switchgear with $t_k = 1$ s	up to kA	25	25	25	25	20	
		for switchgear with $t_k = 3$ s (design option)	up to kA	20					
	Rated peak withstand current I_p	up to kA	63	63	63	63	50		
	Rated short-circuit making current I_{ma}	for ring-main feeders	up to kA	63	63	63	63	50	
		for circuit-breaker feeders	up to kA	63	63	63	63	50	
for transformer feeders		up to kA	63	63	63	63	50		
60 Hz	Rated short-time withstand current I_k	for switchgear with $t_k = 1$ s	up to kA	25	25	25	25	21	
		for switchgear with $t_k = 3$ s (design option)	up to kA	21					
	Rated peak withstand current I_p	up to kA	65	65	65	65	55		
	Rated short-circuit making current I_{ma}	for ring-main feeders	up to kA	65	65	65	65	55	
		for circuit-breaker feeders	up to kA	65	65	65	65	55	
for transformer feeders		kA	65	65	65	65	55		
Filling pressure (pressure values at 20 °C)	Rated filling level p_{re} (absolute)	kPa	150						
	Minimum functional level p_{me} (absolute)	kPa	130						
Ambient air temperature T	without secondary equipment	°C	–25 / –40 ¹⁾ to +55 / +70 ¹⁾						
	with secondary equipment	°C	–25 / –40 ^{1, 4)} to +55 / +70 ^{1, 4)}						
	for storage/transport including secondary systems	°C	–40 to +70						
Degree of protection	for gas-filled switchgear vessel		IP65						
	for switchgear enclosure		IP2X / IP3X ¹⁾						
	for low-voltage compartment		IP3X / IP4X ¹⁾						

1) Design option

2) The rated normal currents apply to ambient air temperatures of max. 40 °C.
The 24-hour mean value is max. 35 °C (according to IEC / EN 62271-1 / VDE 0671-1)

3) Depending on HV HRC fuse-link

4) Depending on the secondary equipment used

Technical Data

Switching capacity and classification of switching devices

Three-position switch-disconnector

Switching capacity for general-purpose switches according to IEC/EN 62271-103 (former: IEC/EN 60265-1/VDE 0670-301)

Rated voltage U_r			kV	7.2	12	15	17.5	24
Test duty TD_{load}	Rated mainly active load	100 operations $I_{load} [I_1]$	A	630				
	breaking current I_{load}	20 operations 0.05 $I_{load} [I_1]$	A	31.5				
Test duty TD_{loop}	Rated closed-loop breaking current $I_{loop} [I_{2a}]$		A	630				
Test duty TD_{cc}	Rated cable-charging breaking current $I_{cc} [I_{4a}]$		A	68				
Test duty TD_{lc}	Rated line-charging breaking current $I_{lc} [I_{4b}]$		A	68				
Test duty TD_{ma}	Rated short-circuit making current I_{ma}	50 Hz	up to kA	63	63	63	63	50
		60 Hz	up to kA	65	65	65	65	55
Test duty TD_{ef1}	Rated earth-fault breaking current $I_{ef1} [I_{6a}]$		A	200				
Test duty TD_{ef2}	Rated cable-charging breaking current and line-charging breaking current under earth-fault conditions $I_{ef2} [I_{6b} (\sqrt{3} \cdot I_{4a}) \text{ or } I_{6b} (\sqrt{3} \cdot I_{4b})]$		A	115				
–	Cable-charging breaking current under earth-fault conditions with superimposed load current $I_1 + \sqrt{3} \cdot I_{4a}$		A	630 + 115				
Number of operating cycles, mechanical / Classification			n	1000 / M1				
Number of operating cycles, electrical with I_{load} / Classification			n	100 / E3				
Number of short-circuit making operations with I_{ma} / Classification			n	5 / E3	5 / E3	5 / E3	5 / E3	5 / E3
C-classification	for general-purpose switches (no restriks, TD: I_{cc} , I_{lc})			C2	C2	C2	C2	C2

Switching capacity for make-proof earthing switch according to IEC/EN 62271-102/VDE 0671-102

Rated short-circuit making current I_{ma}	50 Hz	up to kA	63	63	63	63	50
	60 Hz	up to kA	65	65	65	65	55
Number of operating cycles, mechanical / Classification			n	1000 / M0			
Number of short-circuit making operations			n	5			
Classification				E2			

Switch-disconnector/fuse combination

Switching capacity for switch-disconnector/fuse combination according to IEC/EN 62271-105/VDE 0671-105

Rated normal current	A	200 ¹⁾					
Rated transfer current $I_{transfer}$	A	1500	1500	1300	1300	1300	

Switching capacity for make-proof earthing switch, feeder side, in transformer feeder with HV HRC fuses

Rated short-circuit making current I_{ma}	50 Hz	kA	5				
	60 Hz	kA	5.2				
Rated short-time withstand current I_k with $t_k = 1$ s		kA	2				

1) Depending on HV HRC fuse-link

Vacuum circuit-breaker

Switching capacity according to IEC/EN 62271-100/VDE 0671-100

Type 1.1 with three-position disconnector

Rated voltage U_r		kV	7.2	12	15	17.5	24	
Rated normal current of feeders I_r		A	630					→
50 Hz	Rated short-time withstand current I_k	for switchgear with $t_k = 1$ s	up to kA	25	25	25	25	20
		for switchgear with $t_k = 3$ s	up to kA	20				→
	Rated peak withstand current I_p		up to kA	63	63	63	63	50
	Rated short-circuit breaking current I_{sc}		up to kA	25	25	25	25	20
	Rated short-circuit making current I_{ma}		up to kA	63	63	63	63	50
60 Hz	Rated short-time withstand current I_k	for switchgear with $t_k = 1$ s	up to kA	25	25	25	25	21
		for switchgear with $t_k = 3$ s	up to kA	21				→
	Rated peak withstand current I_p		up to kA	65	65	65	65	55
	Rated short-circuit breaking current I_{sc}		up to kA	25	25	25	25	21
	Rated short-circuit making current I_{ma}		up to kA	65	65	65	65	55
Number of mechanical operating cycles for disconnector		n	1000					→
Number of mechanical operating cycles for earthing switch		n	1000					→
Number of mechanical operating cycles for earthing switch		n	10,000					→
Classification of circuit-breaker			M2, E2, C2, S2					→
Classification of disconnector			M0					→
Classification of make-proof earthing switch			E2					→
Rated operating sequence			O - 0.3 s - CO - 3 min - CO					→
			O - 0.3 s - CO - 15 s - CO on request					→
Number of short-circuit breaking operations		n	25 or 50					→

Type 2 with three-position disconnector

Rated voltage U_r		kV	7.2	12	15	17.5	24	
Rated normal current of feeders I_r		A	250 A or 630 A					→
50 Hz	Rated short-time withstand current I_k	for switchgear with $t_k = 1$ s	up to kA	20				→
		for switchgear with $t_k = 3$ s	up to kA	20				→
	Rated peak withstand current I_p		up to kA	50				→
	Rated short-circuit breaking current I_{sc}		up to kA	20				→
	Rated short-circuit making current I_{ma}		up to kA	50				→
60 Hz	Rated short-time withstand current I_k	for switchgear with $t_k = 1$ s	up to kA	25	25	25	25	20
		for switchgear with $t_k = 3$ s	up to kA	21				→
	Rated peak withstand current I_p		up to kA	65	65	65	65	55
	Rated short-circuit breaking current I_{sc}		up to kA	25	25	25	25	21
	Rated short-circuit making current I_{ma}		up to kA	65	65	65	65	55
Number of mechanical operating cycles for disconnector		n	1000					→
Number of mechanical operating cycles for earthing switch		n	1000					→
Number of mechanical operating cycles for earthing switch		n	2000					→
Classification of circuit-breaker			M1, E2, C1, S1					→
Classification of disconnector			M0					→
Classification of make-proof earthing switch			E2					→
Rated operating sequence			O - 3 min - CO - 3 min - CO					→
Number of short-circuit breaking operations		n	6 or 20					→

Product Range

Individual panels and modules – freely configurable for up to 4 functions in the block

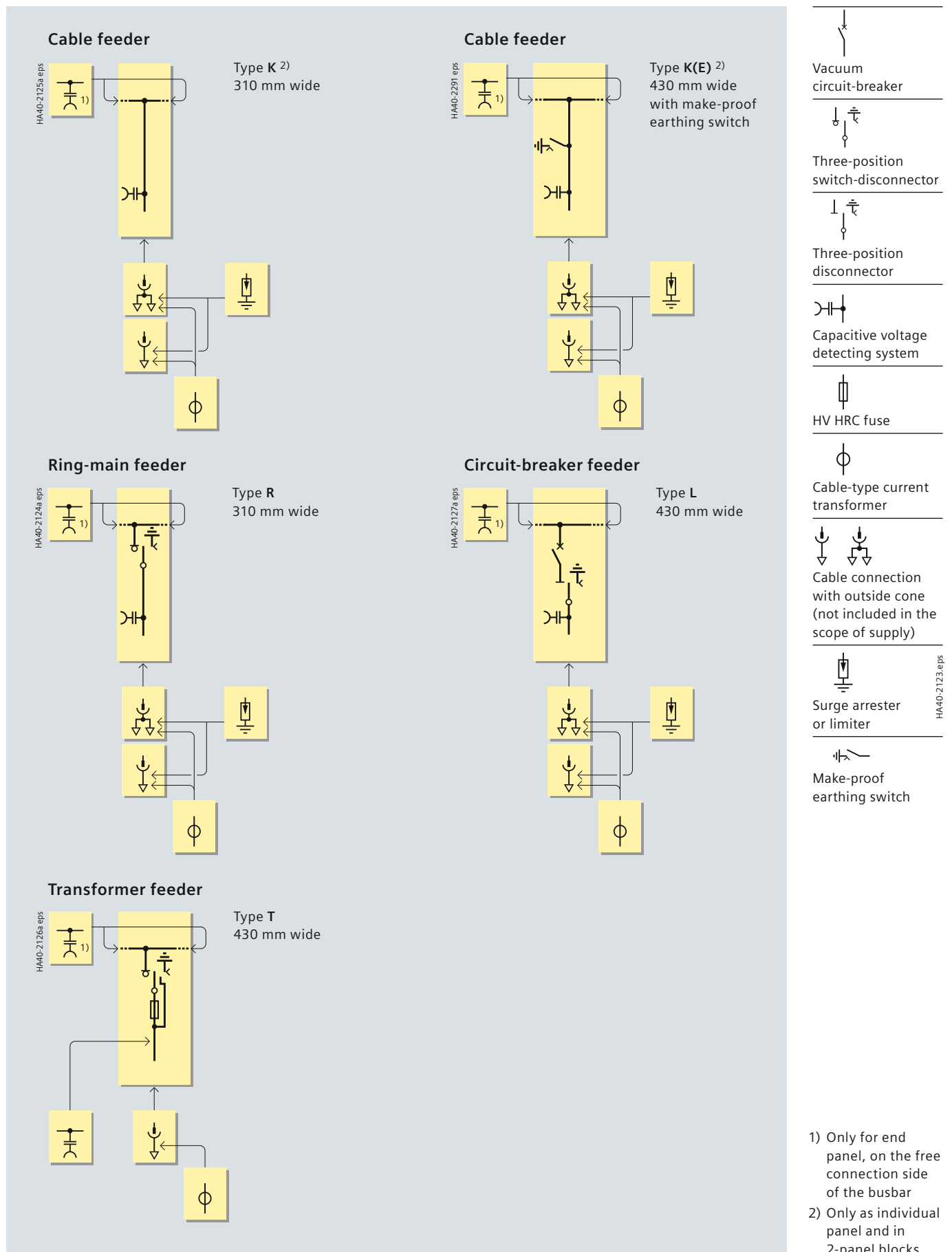

- 1) Only for end panel, on the free connection side of the busbar
- 2) Only as individual panel and in 2-panel blocks

Bus sectionalizer panel/module only on the right in panel blocks with switch-disconnector

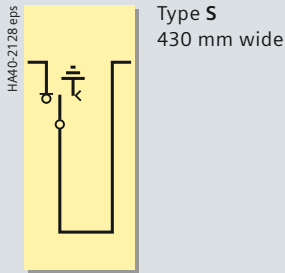

Type S
430 mm wide

with switch-disconnector/fuse combination

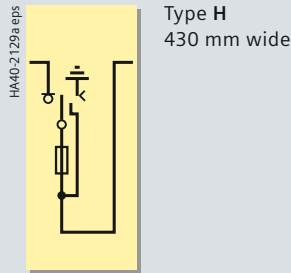

Type H
430 mm wide

Bus sectionalizer panel with switch-disconnector

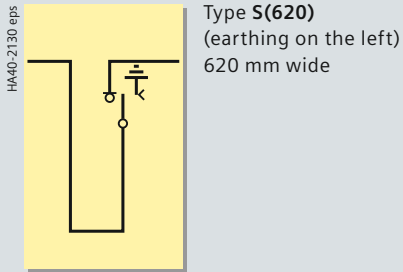

Type S(620)
(earthing on the left)
620 mm wide

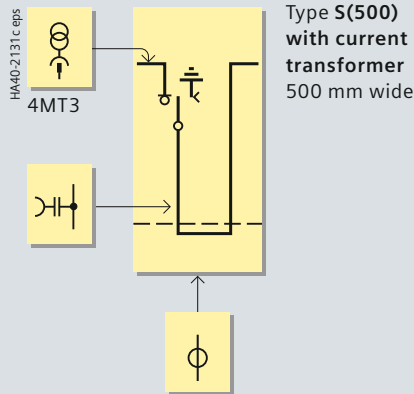

Type S(500)
with current
transformer
500 mm wide

Bus sectionalizer panel with circuit-breaker

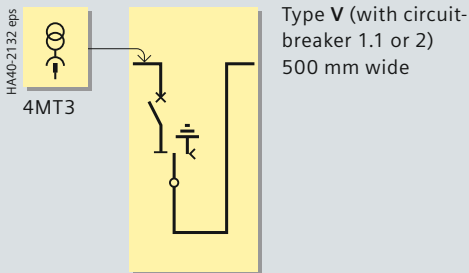

Type V (with circuit-
breaker 1.1 or 2)
500 mm wide

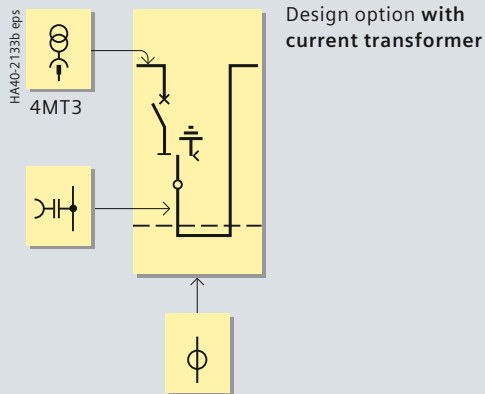

Design option with
current transformer

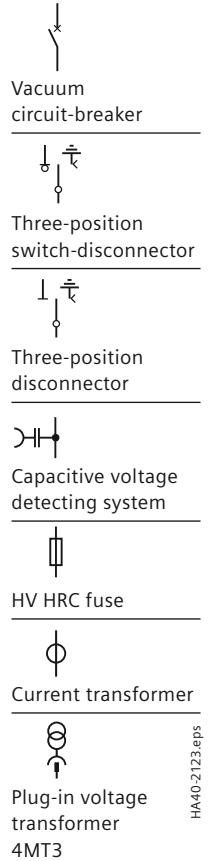

Product Range

Individual panels

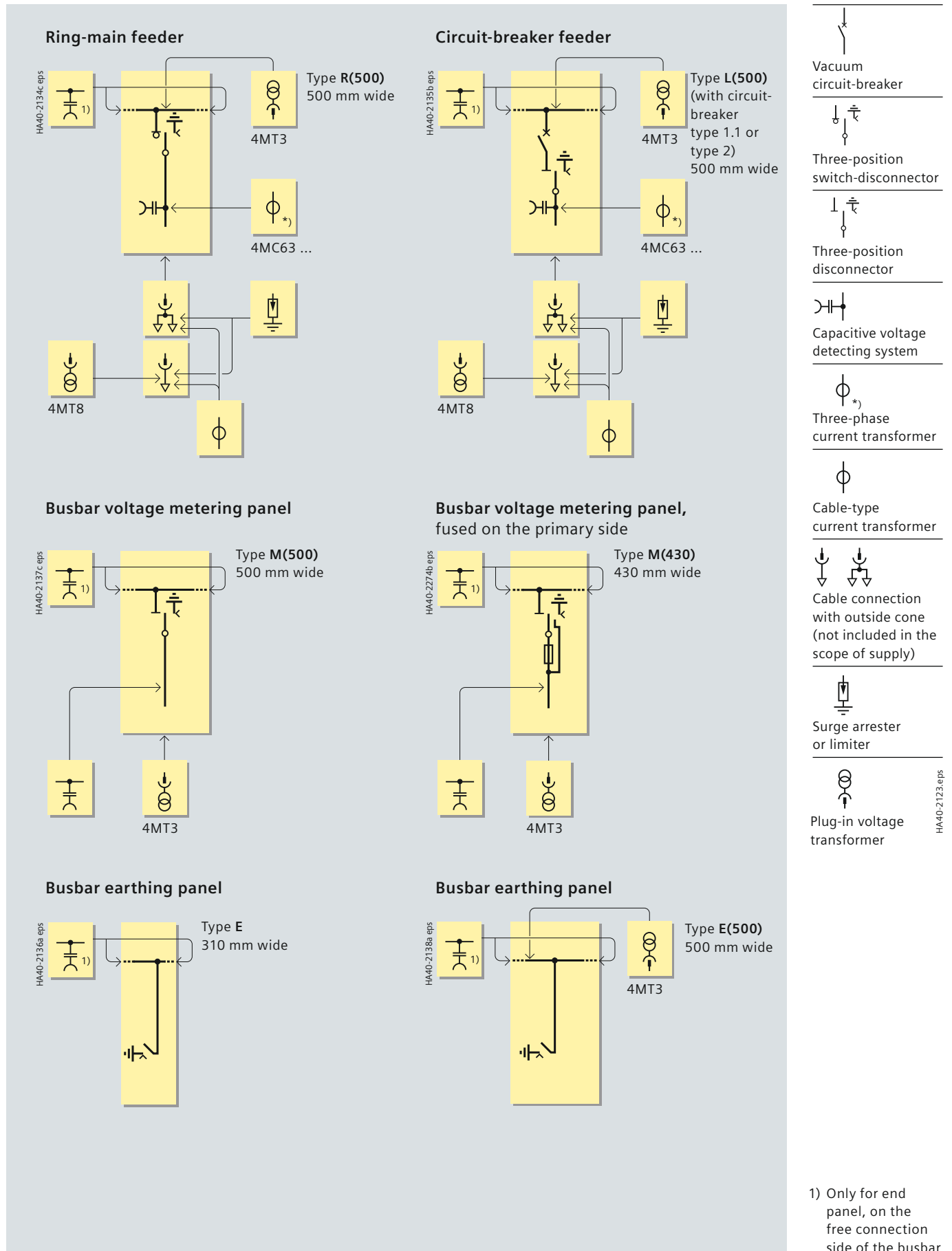

1) Only for end panel, on the free connection side of the busbar

Billing metering panels as transfer panel to the right, with cable connection

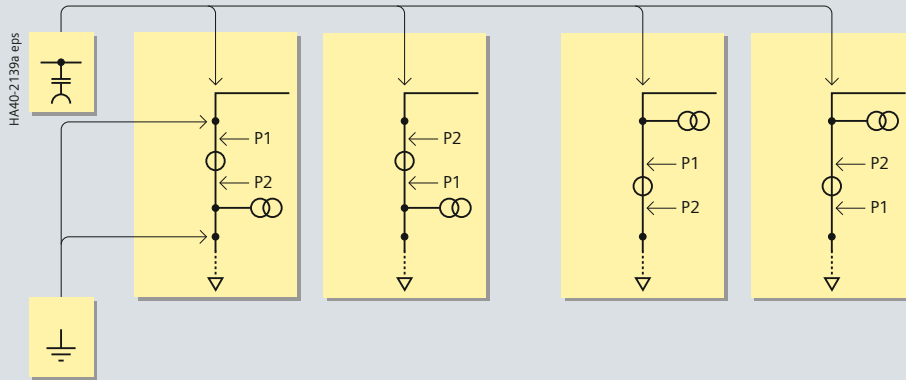

Billing metering panels as transfer panel to the left, with cable connection

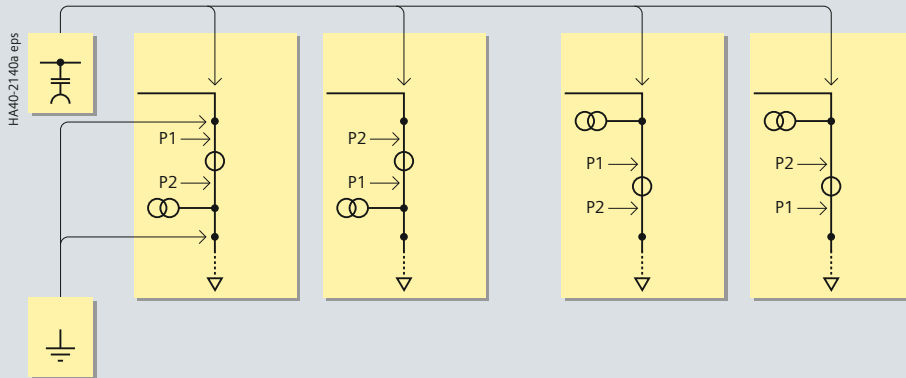

Billing metering panels as transfer panel with busbar connection on both sides

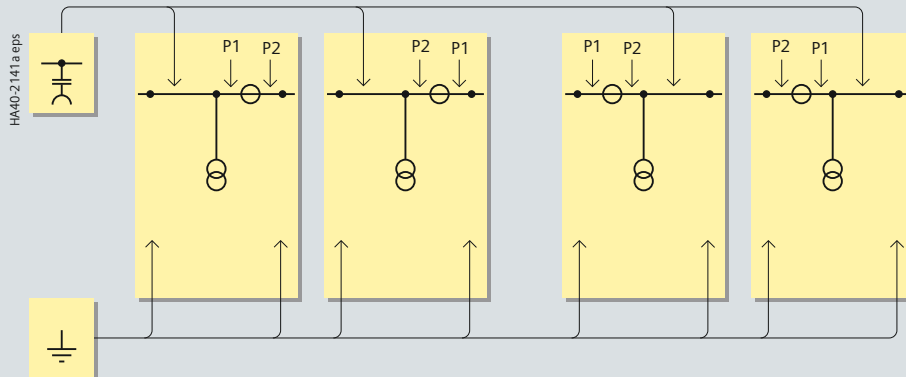

Billing metering panels as transfer panel with cable connection on both sides

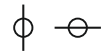
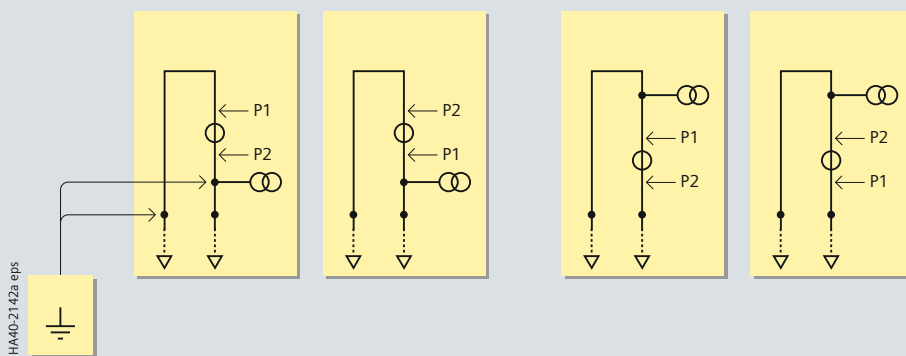

Current transformer, cast-resin insulated



Voltage transformer, cast-resin insulated



Capacitive voltage detecting system



Fixed earthing points for busbar earthing

P1 and P2 are terminal designations of the current transformer

HA40-2123.eps

Product Range

Product range overview of panel blocks (preferred versions)

Panel block Components shown in dotted lines can be used optionally.	Installation dimensions		
	Width	Depth	Height
	mm	mm	mm

Panel block Components shown in dotted lines can be used optionally.	Installation dimensions		
	Width	Depth	Height
	mm	mm	mm

Panel blocks with transformer feeders, optionally with busbar extension

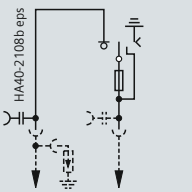
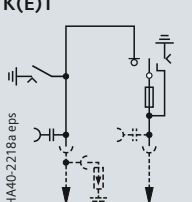
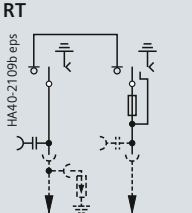
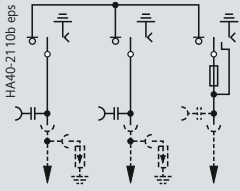
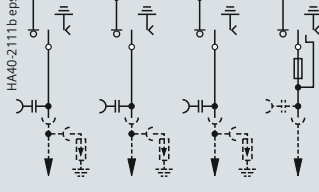
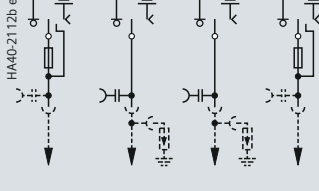
KT 	K Radial cable connection as incoming feeder	1 transformer feeder, 1 radial cable connection	740 775 1200 1400 1700
K(E)T 	K Radial cable connection as incoming feeder	1 transformer feeder, 1 radial cable connection with make-proof earthing switch	860 775 1200 1400 1700
RT 		1 ring-main feeder, 1 transformer feeder	740 775 1040 1200 1400 1700
RRT 		2 ring-main feeders, 1 transformer feeder	1050 775 1040 1200 1400 1700
RRRT 		3 ring-main feeders, 1 transformer feeder	1360 775 1200 1400 1700
TRRT 		2 ring-main feeders, 2 transformer feeders	1480 775 1200 1400 1700

Panel blocks with circuit-breaker feeders, optionally with busbar extension

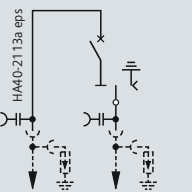
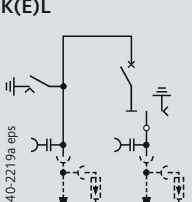
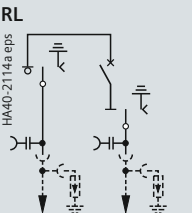
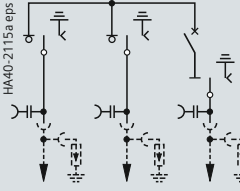
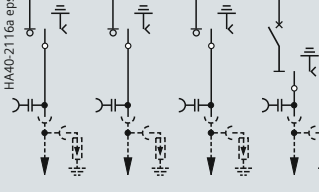
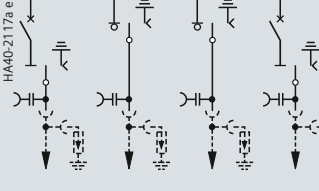
KL 	K Radial cable connection as incoming feeder	1 circuit-breaker feeder, 1 radial cable connection	740 775 1200 1400 1700
K(E)L 	K Radial cable connection as incoming feeder	1 circuit-breaker feeder, 1 radial cable connection with make-proof earthing switch	860 775 1200 1400 1700
RL 		1 ring-main feeder, 1 circuit-breaker feeder	740 775 1200 1400 1700
RRL 		2 ring-main feeders, 1 circuit-breaker feeder	1050 775 1200 1400 1700
RRRL 		3 ring-main feeders, 1 circuit-breaker feeder	1360 775 1200 1400 1700
LRRL 		2 ring-main feeders, 2 circuit-breaker feeders (type 2)	1480 775 1200 1400 1700

Product range overview of panel blocks (preferred versions)

Panel block Components shown in dotted lines can be used optionally.	Installation dimensions		
	Width	Depth	Height
	mm	mm	mm

Panel blocks with ring-main feeders, optionally with busbar extension

RR	2 ring-main feeders		
	620	775	1040
			1200
			1400
			1700
			1700
RRR	3 ring-main feeders		
	930	775	1040
			1200
			1400
			1700
			1700
RRRR	4 ring-main feeders		
	1240	775	1200
			1400
			1700
			1700
			1700

Panel block Components shown in dotted lines can be used optionally.	Installation dimensions		
	Width	Depth	Height
	mm	mm	mm

Panel blocks with transformer feeders, optionally with busbar extension

TT	2 transformer feeders		
	860	775	1200
			1400
			1700
			1700
			1700
TTT	3 transformer feeders		
	1290	775	1200
			1400
			1700
			1700
			1700

Panel block Components shown in dotted lines can be used optionally.	Installation dimensions		
	Width	Depth	Height
	mm	mm	mm

Panel blocks with transformer feeders as 8DJH Compact, without busbar extension

RRT			
	620	775	1400
			1700
	700		1400
	1700		
RRT-R			
	930	775	1400
			1700
	1010		1400
	1700		
RRT-RRT			
	1240	775	1400
			1700
	1400		1400
	1700		

Design

Panel design (examples)

Ring-main feeder

Type R

Section

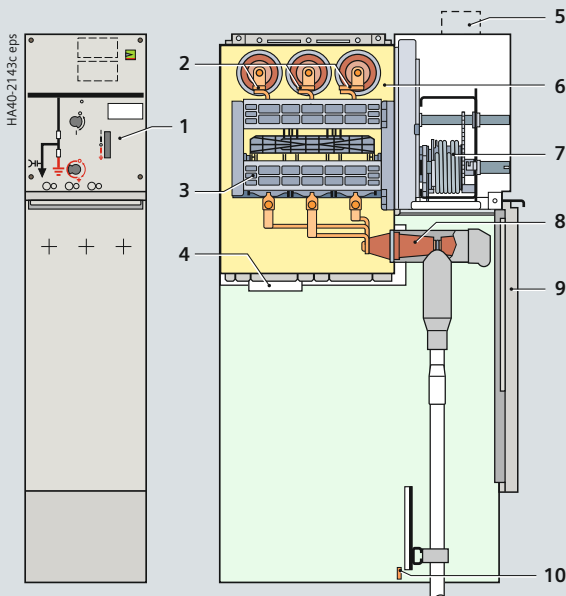

Transformer feeder

Type T

Section

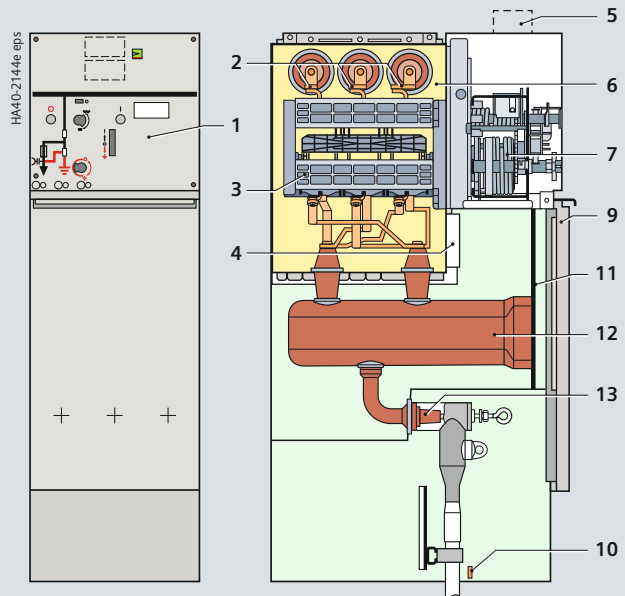

Circuit-breaker feeder

Type L

Section

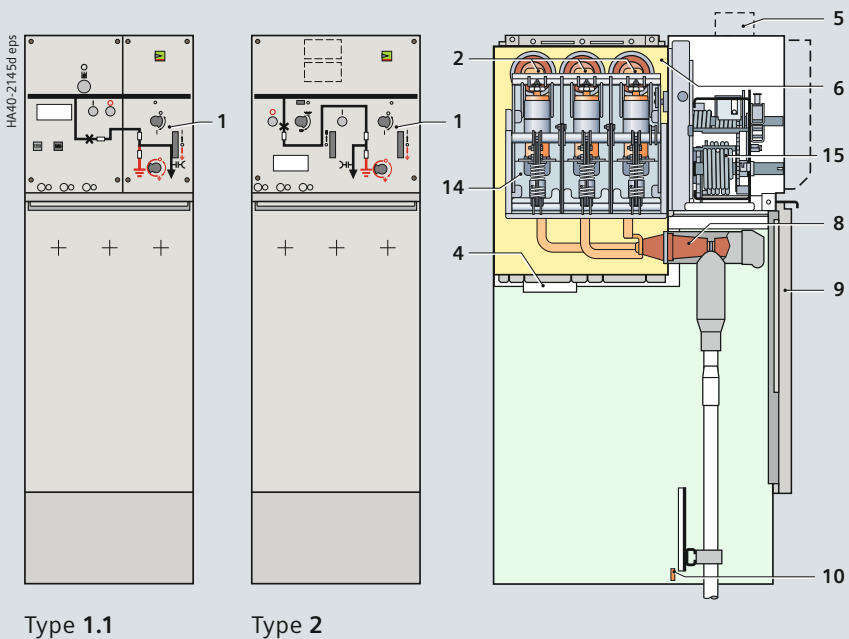

- 1 Control board (for details, see page 23)
- 2 Busbar arrangement
- 3 Three-position switch-disconnector
- 4 Pressure relief device
- 5 Wiring duct, removable, for protection and/or bus wires
- 6 Switchgear vessel, filled with gas
- 7 Operating mechanism of switching device
- 8 Bushing for cable plug with bolted contact (M16)
- 9 Cable compartment cover
- 10 Earthing busbar with earthing connection
- 11 Partition
- 12 HV HRC fuse assembly
- 13 Bushing for cable plug with plug-in contact, optionally bolted contact (M16)
- 14 Vacuum circuit-breaker
- 15 Circuit-breaker operating mechanism, operating mechanism for three-position disconnector

Circuit-breaker feeder

Type L(500)

Section

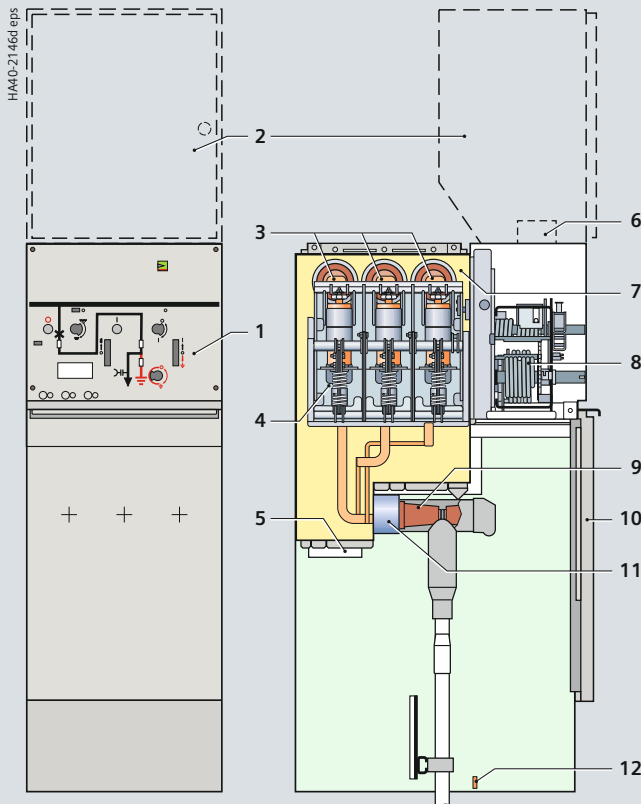

- 1 Control board (for details, see page 23)
- 2 Option: Low-voltage compartment
- 3 Busbar arrangement
- 4 Vacuum circuit-breaker
- 5 Pressure relief device
- 6 Wiring duct, removable, for protection and/or bus wires
- 7 Switchgear vessel, filled with gas
- 8 Operating mechanism of switching device
- 9 Bushing for cable plug with bolted contact (M16)
- 10 Cable compartment cover
- 11 Option: Three-phase current transformer (protection transformer)
- 12 Earthing busbar with earthing connection

Type 2

Section

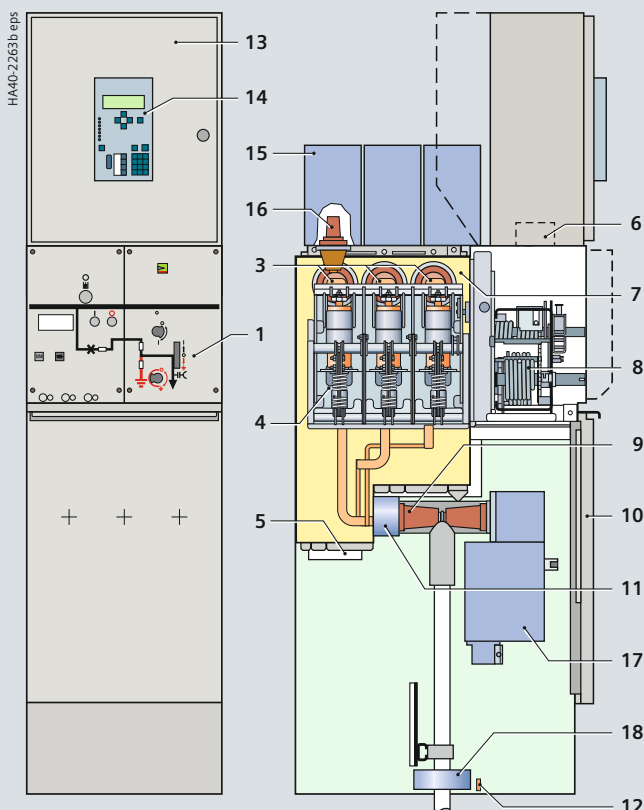

- 13 Low-voltage compartment (standard) for vacuum circuit-breaker
- 14 Option: SIPROTEC bay controller
- 15 Option: Plug-in voltage transformer type 4MT3 on the busbar
- 16 Bushing for connection of plug-in voltage transformers
- 17 Option: Plug-in voltage transformer 4MT8 at the connection
- 18 Cable-type current transformer

Type 1.1

Design

Panel design (examples)

Billing metering panel Type M, air-insulated

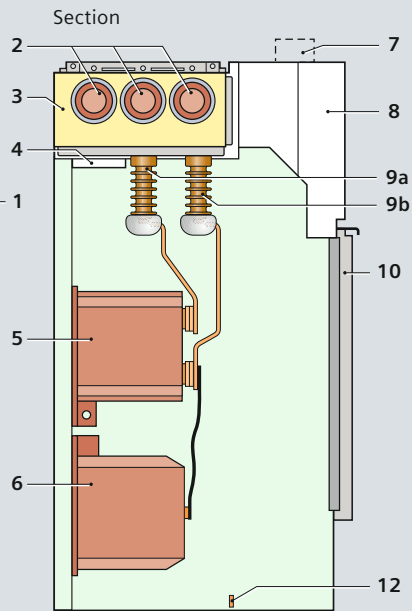
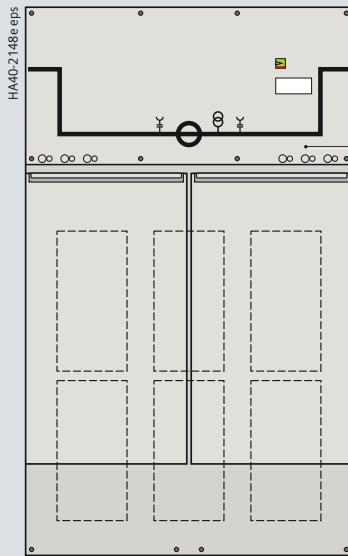

Connection: busbar – busbar

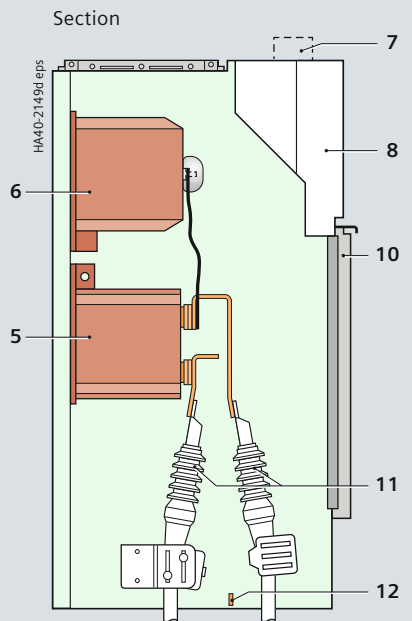

- 1 Sockets for voltage detecting system
- 2 Busbar connection
- 3 Busbar vessel, filled with gas
- 4 Pressure relief device
- 5 Current transformer type 4MA7
- 6 Voltage transformer type 4MR
- 7 Wiring duct, removable, for protection and/or bus wires
- 8 Niche for customer-side low-voltage equipment, screwed cover
- 9 Bushings for connection of transformer bars, connected with busbar extension on the right **9a** and on the left **9b**
- 10 Transformer compartment cover
- 11 Cable connection
- 12 Earthing busbar with earthing connection

Connection: cable – cable

Panel block Type 8DJH Compact RRT

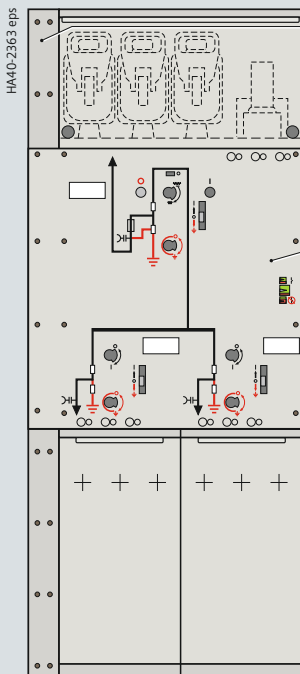

Section

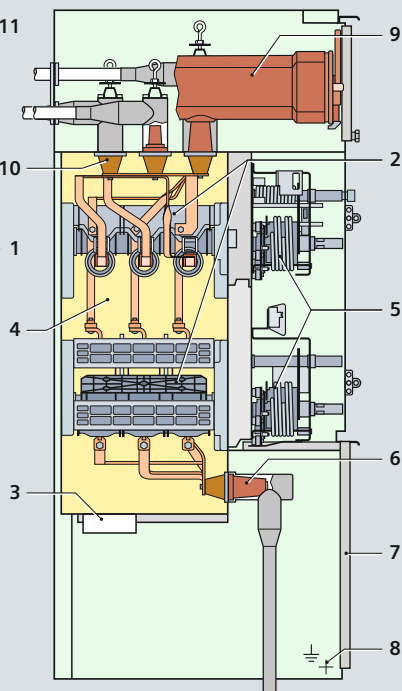

- 1 Control board (for details, see page 23)
- 2 Three-position switch-disconnector
- 3 Pressure relief device
- 4 Switchgear vessel, filled with gas
- 5 Operating mechanism of switching device
- 6 Bushing for cable plug with bolted contact (M16)
- 7 Cable compartment cover
- 8 Earthing busbar with earthing connection
- 9 HV HRC fuse assembly
- 10 Bushing for cable plug with plug-in contact
- 11 Pressure relief duct downwards for transformer feeder (option)

Design

Outdoor enclosure

On request, 8DJH switchgear can be provided with an outdoor enclosure with the following features:

- For outdoor applications on company grounds
- Enclosure attached to standard indoor panels
- Enclosure with three different heights, for 1200 mm switchgear height (optionally with low-voltage compartment as a 200 mm, 400 mm or 600 mm high version), or 1400 mm switchgear height (optionally with low-voltage compartment as a 200 mm or 400 mm high version)
- Enclosure with four different widths for freely configurable, non-extendable switchgear rows up to a switchgear width of 2000 mm (for dimensions, see page 82)
- Internal arc classification IAC A FL or FLR to 21 kA/1 s according to IEC 62271-200
- Degree of protection IP 54.



Outdoor enclosure (front closed)



Outdoor enclosure (front open)

The control boards are function-related. They integrate operation, mimic diagram and position indication. Furthermore, indicating, measuring and monitoring equipment as well as locking devices and local-remote switches are arranged according to the panel type and version. The ready-for-service indicator and rating plates are fitted in accordance with the panel blocks.

Operation is identical for transformer and circuit-breaker feeders. First, the operating mechanism must be charged; then, closing/opening is done through separate pushbuttons. The condition of the energy store is indicated.

All actuating openings are functionally interlocked against each other, and are optionally lockable. Separate operating levers for the disconnecting and earthing function are optionally available.

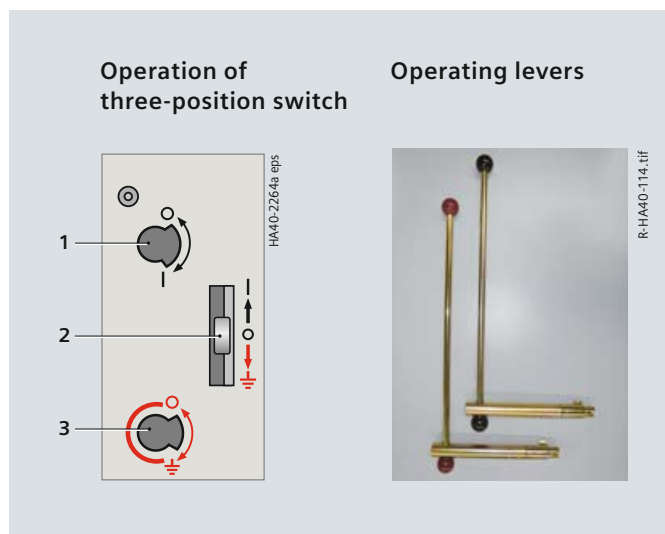

- 1 Manual operation of load-break function
- 2 Locking function (option for ring-main feeders)
- 3 Manual operation of earthing function
- 4 Panel designation label
- 5 Position indicator for switch-disconnector
- 6 Position indicator for earthing switch
- 7 Sockets of capacitive voltage detecting system
- 8 "Fuse tripped" indicator
- 9 ON pushbutton for transformer or circuit-breaker function
- 10 OFF pushbutton for transformer or circuit-breaker function
- 11 Manual spring charging
- 12 "Spring charged" indicator
- 13 Position indicator for circuit-breaker

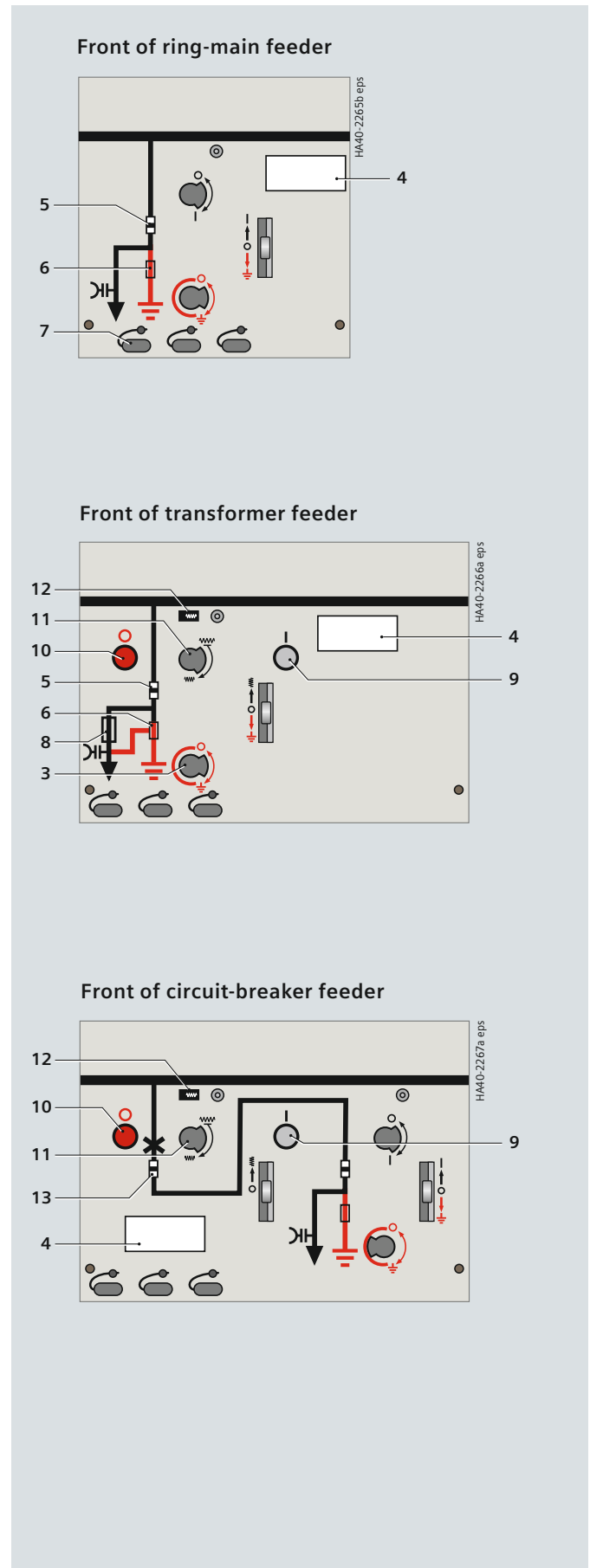

Components

Three-position switch-disconnector

Features

- Switch positions:
CLOSED – OPEN – EARTHED
- Switching functions as general-purpose switch-disconnector (class E3) according to
 - IEC/EN 62271-103/VDE 0671-103
 - IEC/EN 62271-102/VDE 0671-102
- Designed as a three-position switch with the functions
 - Switch-disconnector and
 - Make-proof earthing switch
- Operation via rotary bushing welded gas-tight into the front of the switchgear vessel
- Climate-independent contact in the gas-filled switchgear vessel
- Maintenance-free for indoor installation according to IEC/EN 62271-1/VDE 0671-1
- Individual secondary equipment.

Mode of operation

The operating shaft forms one unit together with the three contact blades. Due to the arrangement of the fixed contacts (earth – busbar), it is not necessary to interlock the CLOSE and EARTHING functions.

Closing operation

During the closing operation, the operating shaft with the moving contact blades changes from the "OPEN" to the "CLOSED" position.

The force of the spring-operated mechanism ensures a high operator-independent closing speed and a reliable connection of the main circuit.

Opening operation

During the opening operation, the arc is caused to rotate by the arc-suppression system. This rotation movement prevents the development of a fixed root.

The isolating distance in gas established after breaking fulfills the conditions applicable to isolating distances in accordance with

- IEC/EN 62271-102/VDE 0671-102
- and
- IEC/EN 62271-1/VDE 0671-1.

Due to the arc rotation caused by the arc-suppression system, both load currents and minor no-load currents are safely interrupted.

Earthing operation

The EARTHING operation is implemented by changing from the "OPEN" to the "EARTHED" position.

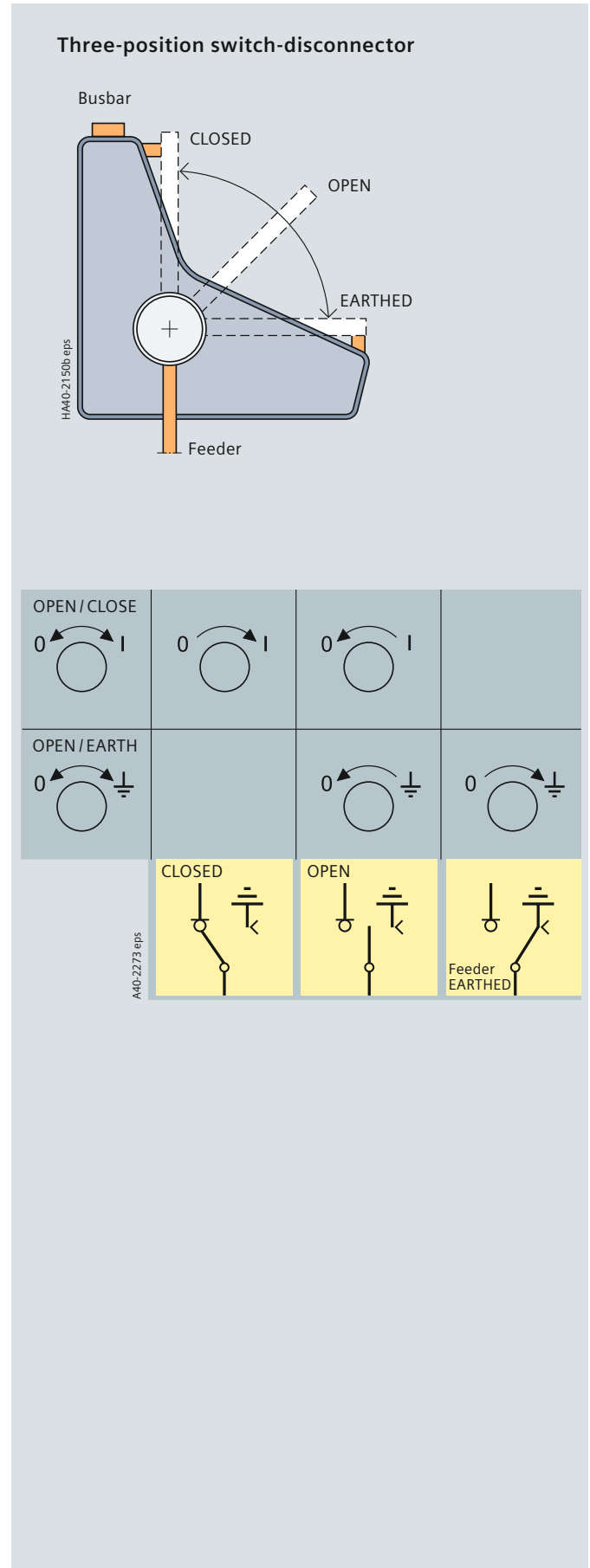

Features

- Mechanical endurance of more than 1000 operating cycles
- Parts subjected to mechanical stress are made of non-rusting materials
- Manual operation with the help of a slip-on operating lever
- Option: Motor operation
- Control board with accordingly cut-out switching gate prevents the three-position switch-disconnector from being switched directly from the "CLOSED" via the "OPEN" to the "EARTHED" position.
- Two separate actuating openings are provided for unambiguous selection of the DISCONNECTING and EARTHING functions.
- Operation via rotary movement, operating direction according to IEC/EN 60447/VDE 0196 (FNN recommendation, former VDN/VDEW recommendation).

Spring-operated mechanism

The switching movements are performed independently of the operating speed.

Spring-operated/stored-energy mechanism

The switching movements are performed independently of the operating speed.

During the charging process, the closing and opening springs are charged. This ensures that the switch-disconnector/fuse combination can switch off all types of faults reliably even during closing.

Closing and opening is done via pushbuttons, and is therefore identical with the operation of circuit-breaker operating mechanisms.

An energy store is available for tripping by means of an operating HV HRC fuse or via a shunt release (f-release).

After tripping, a red bar appears on the position indicator.

Assignment of operating mechanism type of three-position switch to panel types

Panel type	R, S, L, V, M(500)		T, H, M(430)	
Function	Switch-disconnector (R, S) Disconnecter (L, V, M(500))	Earthing switch	Switch-disconnector (T, H) Disconnecter M(430)	Earthing switch
Type of operating mechanism	Spring-operated	Spring-operated	Stored-energy	Spring-operated
Operation	Manual Motor (option)	Manual	Manual Motor (option)	Manual

Legend:

- R = Ring-main feeder
- S = Bus sectionalizer panel with switch-disconnector
- L = Circuit-breaker feeder
- T = Transformer feeder
- H = Bus sectionalizer panel with switch-disconnector/fuse combination
- V = Bus sectionalizer panel with circuit-breaker
- M(430)/M(500) = Busbar voltage metering panel

Components

Operating mechanisms for the three-position switch, equipment (optional)

Motor operating mechanism (option)

The manual operating mechanisms of 8DJH switchgear can be equipped with motor operating mechanisms for the three-position switch-disconnector. Retrofitting is possible.

Operating voltages for motor operating mechanisms:

- 24, 48, 60, 110, 220 V DC
- 110 and 230 V AC, 50/60 Hz
- Motor rating: max. 80 W/80 VA.

Operation:

- Local operation by momentary-contact rotary control switch (option)
- Remote operation (standard) applied to terminal.

Shunt release (option)

(f-release)

Stored-energy mechanisms can be equipped with a shunt release. Remote electrical tripping of the three-position switch-disconnector is possible via the magnet coil of the shunt release, e.g. transformer overtemperature tripping.

To avoid thermal overloading of the shunt release in the event of a continuous signal that may be applied, the shunt release is switched off via an auxiliary switch which is mechanically coupled with the three-position switch-disconnector.

Auxiliary switch (option)

Each operating mechanism of the three-position switch-disconnector can be optionally equipped with an auxiliary switch for the position indication. Free contacts (for manual operating mechanism):

- Switch-disconnector function:
CLOSED and OPEN: 1 NO + 1 NC + 2 changeover contacts
- Earthing switch function:
CLOSED and OPEN: 1 NO + 1 NC + 2 changeover contacts.

Technical data of the auxiliary switch

Breaking capacity

AC operation at 40 Hz up to 60 Hz		DC operation		
Operating voltage	Normal current	Operating voltage	Normal current Resistive Inductive, T = 20 ms	
V	A	V	A	A
up to 230	10	24	10	10
		48	10	9
		60	9	7
		110	5	4
		240	2.5	2

Rated switching capacity

Rated insulation voltage	250 V AC/DC
Insulation group	C acc. to VDE 0110
Continuous current	10 A
Making capacity	50 A

Abbreviations:

NO = Normally open contact

NC = Normally closed contact

Features

- The vacuum circuit-breaker consists of a vacuum interrupter unit with integrated three-position disconnecter located in the switchgear vessel, and the associated operating mechanisms.
- According to IEC/EN 62271-100/VDE 0671-100
- Application in hermetically welded switchgear vessel in conformity with the system
- Climate-independent vacuum interrupter poles in the gas-filled switchgear vessel
- Operating mechanism located outside the switchgear vessel in the front operating mechanism box
- Maintenance-free for indoor installation according to IEC/EN 62271-1/VDE 0671-1
- Individual secondary equipment.

Operating mechanism functions

The closing spring is charged by means of the operating lever or the hand crank supplied, or by the motor (option), until the latching of the closing spring is indicated ("spring charged" indicator). Then, the vacuum circuit-breaker can be closed manually or electrically.

In operating mechanisms provided for automatic reclosing (AR), the closing spring can be recharged by hand or automatically in case of motor operating mechanism. Thus, the "closing option" is available again.

Operating mechanism

The operating mechanism assigned to a circuit-breaker feeder consists of the following components:

- Operating mechanism for circuit-breaker
- Operating mechanism for three-position disconnecter
- Motor operating mechanism (optional)
- Position indicators
- Pushbuttons for CLOSING and OPENING the circuit-breaker
- Interlocking between circuit-breaker and disconnecter.

Assignment of operating mechanism type

Panel type	L, V		
Function	Circuit-breaker	Three-position disconnecter	
		Disconnecter	Earthing switch
Type	Stored-energy	Spring-operated	Spring-operated
Operation	Manual/Motor	Manual/Motor	Manual

Trip-free mechanism

The vacuum circuit-breaker is fitted with a trip-free mechanism according to IEC/EN 62271-100/VDE 0671-100. In the event of an opening command being given after a closing operation has been initiated, the moving contacts return to the open position and remain there even if the closing command is sustained. This means that the contacts are momentarily in the closed position, which is permissible according to the above-mentioned standard.

Circuit-breaker

Circuit-breaker	Type 1.1	Type 2
Short-circuit breaking current	up to 17.5 kV/25 kA or 24 kV/21 kA	up to 17.5 kV/25 kA or 24 kV/21 kA
Rated operating sequence		
O - 0.3 s - CO - 3 min - CO	•	–
O - 0.3 s - CO - 15 s - CO	on request	–
O - 3 min - CO - 3 min - CO	–	•
Number of breaking operations I_n	10,000	2000
short-circuit breaking operations I_{SC}	up to 50	up to 20
In individual panel	430 mm	•
	500 mm	•
In panel block	430 mm	•

Explanations:

- Design option
- Not available

Components

Vacuum circuit-breaker

Electrical service life

Vacuum circuit-breaker type 1.1

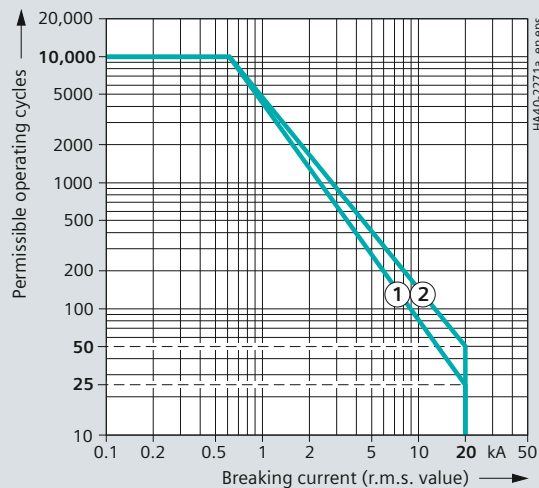

Rated short-circuit breaking current 20 kA

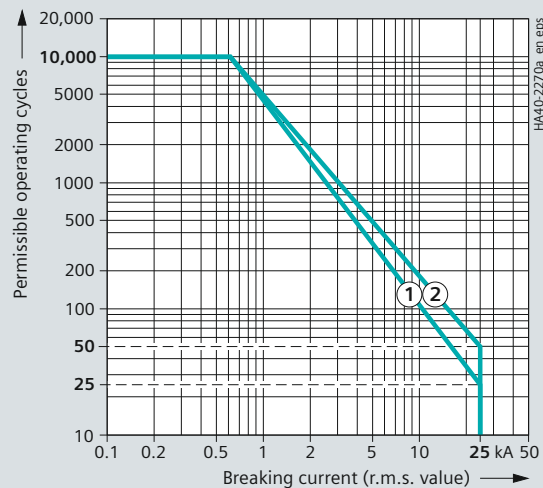

Rated short-circuit breaking current 25 kA

Vacuum circuit-breaker type 2

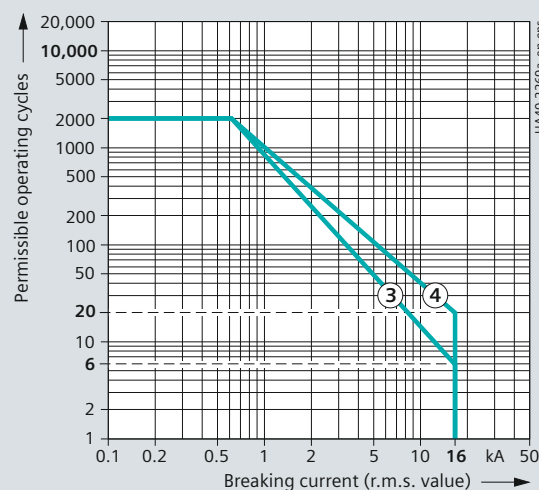

Rated short-circuit breaking current 16 kA

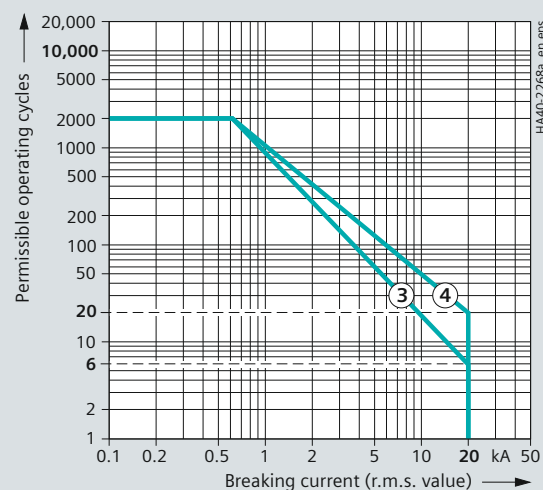

Rated short-circuit breaking current 20 kA

Max. number of short-circuit breaking operations

- | | |
|----------|----------|
| ① n = 25 | ③ n = 6 |
| ② n = 50 | ④ n = 20 |

Motor operating mechanism

Operating voltages for motor operating mechanisms:

- 24, 48, 60, 110, 220 V DC
- 110 and 230 V AC, 50/60 Hz.

Further values on request.

Motor rating for circuit-breaker operating mechanism type 1.1 at

24 V to 220 V DC: maximum 500 W

110 V and 230 V AC: maximum 650 VA.

Motor rating for disconnecter operating mechanism and circuit-breaker operating mechanism type 2 at

DC: maximum 80 W

AC: maximum 80 VA.

Secondary components

The scope of the secondary equipment of the vacuum circuit-breaker depends on the type of application and offers a wide range of possible variations, allowing almost every requirement to be satisfied.

Closing solenoid

- For electrical closing.

Shunt release

- Magnet coil for tripping by protection device or electrical actuation.

C.t.-operated release

- For tripping pulse 0.1 Ws in conjunction with suitable protection systems, e.g. protection system 7SJ45 or make Woodward/SEG type WIC; other designs on request
- Used if external auxiliary voltage is missing, tripping via protection relay.

Low-energy magnetic release

- For tripping pulse 0.02 Ws, tripping via transformer monitor (IKI-30).

Undervoltage release

- Comprising:
 - Energy store and unlatching mechanism
 - Electromagnetic system, which is permanently connected to voltage while the vacuum circuit-breaker is closed; tripping is initiated when this voltage drops.

Anti-pumping

(mechanical and electrical)

- Function: If constant CLOSE and OPEN commands are present at the vacuum circuit-breaker at the same time, the vacuum circuit-breaker will return to the open position after closing. It remains in this position until a new CLOSE command is given. In this manner, continuous closing and opening (= pumping) is avoided.

1) Depending on the secondary components selected; equipment example with closing solenoid and 1 shunt release

Circuit-breaker tripping signal

- For electrical signaling (as pulse > 10 ms), e.g. to remote control systems, in the case of automatic tripping (e.g. protection)
- Via limit switch and cutout switch.

Varistor module

- To limit overvoltages to approx. 500 V for protection devices (when inductive components are mounted in the vacuum circuit-breaker)
- For auxiliary voltages ≥ 60 V DC.

Auxiliary switch

- For electrical position indication.

Position switch

- For signaling "closing spring charged".

Mechanical interlocking

- Dependent on the type of operating mechanism
- Interrogation of the three-position disconnecter from the switchgear side
- Option: Operating mechanism with mechanical interlocking as
 - Stored-energy mechanism with closing solenoid and pushbutton: The pushbutton operated by the mechanical interlocking prevents a continuous command to the closing solenoid
- During operation of the three-position disconnecter from CLOSED to OPEN, the vacuum circuit-breaker cannot be closed.

Operations counter

- As numeric indicator, 5 digits, mechanical.

Circuit-breaker equipment

Circuit-breaker	Type 1.1	Type 2
Motor operating mechanism	○	○
Closing solenoid	●	○
Shunt release	○	○
C.t.-operated release	○	○
Low-energy magnetic release	–	○
Undervoltage release	○	○
Anti-pumping	●	o.r.
Circuit-breaker tripping signal	●	○
Varistor module	for DC ≥ 60 V	for DC ≥ 60 V
Auxiliary switch		
6 NO + NC	●	●
free contacts thereof ¹⁾	2 NO + 2 NC + 2 changeover	2 NO + 3 NC + 2 changeover
11 NO + 11 NC	○	–
free contacts thereof ¹⁾	7 NO + 7 NC + 2 changeover	–
Position switch	●	●
Mechanical interlocking	●	●
Operations counter	●	○

● = standard
○ = option
o.r. = on request

Abbreviations:

NO = Normally open contact
NC = Normally closed contact

Components

Busbar extension, modularity

Features

- Busbar extension possible on all individual panels and panel blocks (ordering option)
- Plug-in unit consisting of contact coupling and screened silicone coupling
- Insensitive to pollution and condensation
- Switchgear installation, extension or panel replacement is possible without gas work
- Busbar connections to metering panels are possible.

Every panel block and every individual panel is optionally available with busbar extension on the right, on the left or on both sides. This offers a high flexibility for the creation of switchgear configurations whose functional units can be lined up in any order. Local installation and lining up is done without gas work.

Lining up takes place as follows:

- By the busbar couplings on the medium-voltage side. Tolerances between adjacent panels are compensated by spherical fixed contacts and the movable contact coupling with degrees of freedom in all axis directions.
- By safe dielectric sealing with screened silicone couplings that are externally earthed and adjustable to tolerances. These silicone couplings are pressed on with a defined pressure when the panels are interconnected.
- On free busbar ends, screened dummy plugs are inserted, each of which is pressed on through a metal cover. A common protective cover with a warning is fixed over all three covers.
- By centering bolts for easier switchgear installation and fixing of adjacent panels.
- By bolted panel joints with defined stops for the distances between adjacent panels and the associated pressure for contact pieces and silicone couplings.

Switchgear installation, extension or replacement of one or more functional units requires a lateral wall distance ≥ 200 mm.

Interconnecting the panels

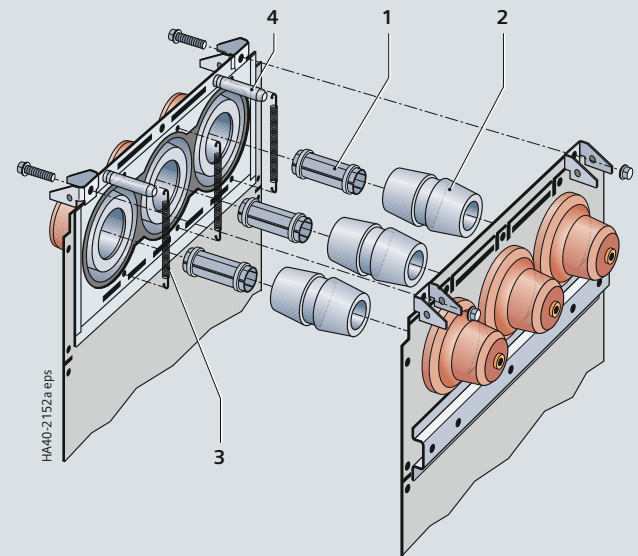

Surge-proof termination

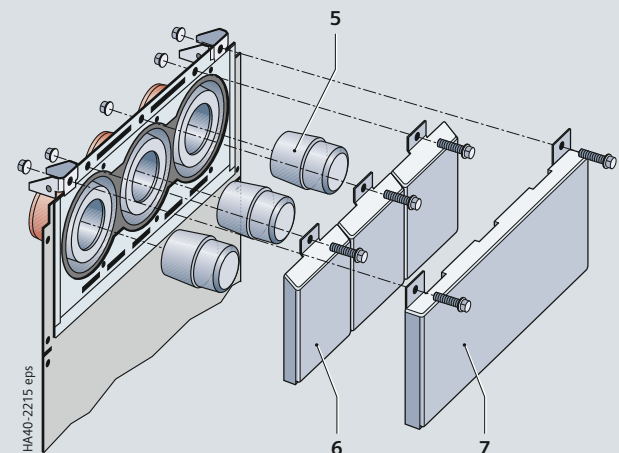

- 1 Contact piece
- 2 Silicone coupling
- 3 Tension spring for earthing
- 4 Centering bolt
- 5 Silicone dummy plug with insertable sleeve
- 6 Clamping cover for dummy plugs
- 7 Busbar termination cover

Features

- Application in switch-disconnector/fuse combination in
 - Transformer feeders (T)
 - Bus sectionalizer with switch-disconnector/fuse combination (H)
 - HV HRC fuse-links according to DIN 43625 (main dimensions) with striker; "medium" version according to IEC/EN 60282-1/VDE 0670-4
 - As short-circuit protection for transformers
 - With selectivity – depending on correct selection – to upstream and downstream connected equipment
 - 1-pole insulated
 - Requirements according to IEC/EN 62271-105/VDE 0671-105 fulfilled in high-voltage switch-fuse combinations
 - Climate-independent and maintenance-free
 - Fuse assembly connected to the three-position switch-disconnector via welded-in bushings and connecting bars
 - Arrangement of fuse assembly below the switchgear vessel
 - Fuses can only be replaced if feeder is earthed
 - Fuse slide for reference dimension 292 mm and 442 mm
- Option with three-position switch-disconnector
- Shunt release (f-release)
 - "Tripped signal" of the transformer switch for remote electrical indication with 1 normally open contact.

Mode of operation

In the event that an HV HRC fuse-link has tripped, the switch-disconnector is tripped via an articulation which is integrated into the cover of the fuse box (see figure).

In the event that the fuse tripping fails, e.g. if the fuse has been inserted incorrectly, the fuse box is protected by thermal protection. The overpressure generated by overheating trips the switch via the diaphragm in the cover of the fuse box and via an articulation. This prevents the fuse box from incurring irreparable damage.

This thermal protection works independently of the type and design of the HV HRC fuse used. Like the fuse itself, it is maintenance-free and independent of any outside climatic effects.

Furthermore, the HV HRC fuses (e.g. make SIBA) release the striker depending on the temperature and trip the switch-disconnector as early as in the fuse overload range. Impermissible heating of the fuse box can be avoided in this way.

Replacement of HV HRC fuse-links (without tools)

- Isolate and earth the transformer feeder
- Open the cover of the fuse access
- Replace the HV HRC fuse-link.

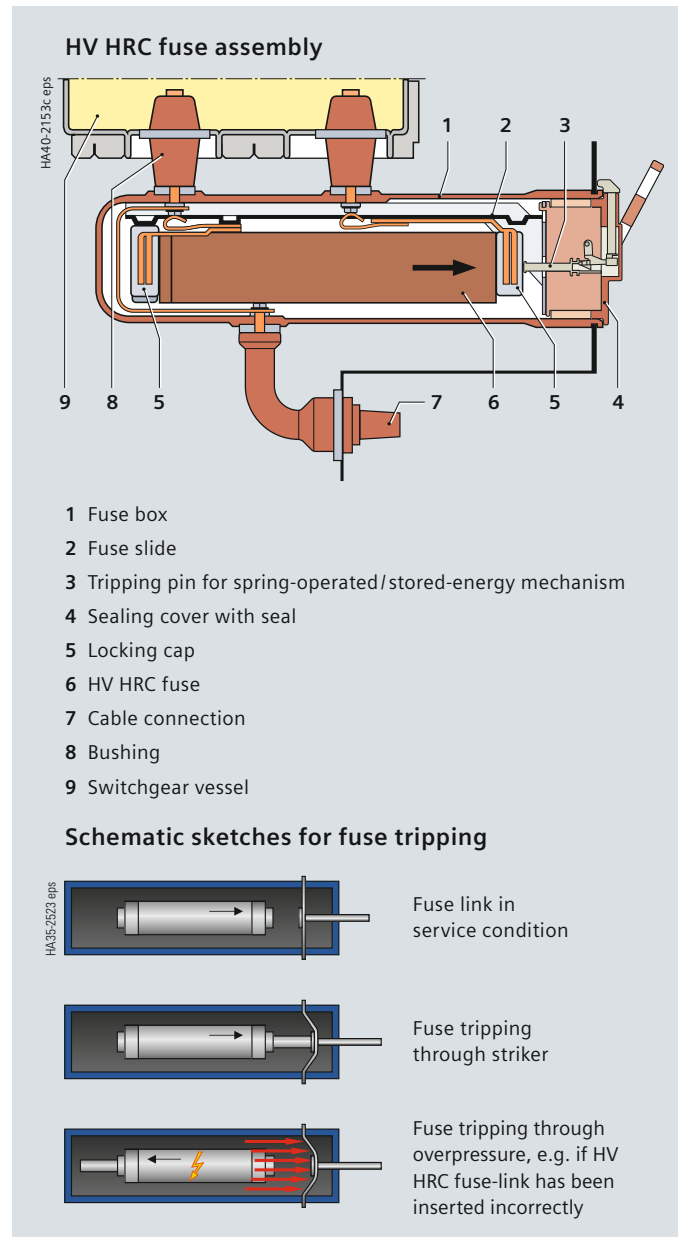

Note to HV HRC fuse-links

According to IEC 60282-1 (2009) Clause 6.6, the breaking capacity of HV HRC fuses is tested within the scope of the type test at 87% of their rated voltage. In three-phase systems with resonance-earthed or isolated neutral, under double earth fault and other conditions, the full phase-to-phase voltage may be available at the HV HRC fuse during breaking. Depending on the size of the operating voltage of such a system, this applied voltage may then exceed 87% of the rated voltage. It must therefore already be ensured during configuration of the switching devices and selection of the HV HRC fuse that only such fuse-links are used, which either satisfy the above operating conditions, or whose breaking capacity was tested at least with the maximum system voltage. In case of doubt, a suitable HV HRC fuse must be selected together with the fuse manufacturer.

Components

Allocation of HV HRC fuses and transformer ratings

Fuse protection table

The following table shows the recommended HV HRC fuse-links make SIBA and Mersen (electrical data valid for ambient air temperatures of up to 40 °C) for fuse protection of transformers.

Standards

HV HRC fuse-links "medium" version with striker and for tripping energy 1 ± 0.5 Joule according to

- IEC/EN 60282-1/VDE 0670-4
- IEC/EN 60787/VDE 0670-402
- DIN 43625 main dimensions.

System operating voltage U_n kV	Transformer			HV HRC fuse			Make Siba	Make Mersen
	Rated power S_N	Relative impedance voltage u_k %	Rated current I_1	Rated current of fuse I_{fuse}	Operating voltage U_{fuse} kV	Dimension e	Order No.	Order No.
	kVA		A	A		mm		
3.3-3.6	20	4	3.5	6.3	3-7.2	292	30 098 13.6,3	–
				10	3-7.2	292	30 098 13.10	–
	30	4	5.25	10	3-7.2	292	30 098 13.10	–
				16	3-7.2	292	30 098 13.16	–
	50	4	8.75	16	3-7.2	292	30 098 13.16	–
				20	3-7.2	292	30 098 13.20	–
	75	4	13.1	20	3-7.2	292	30 098 13.20	–
				25	3-7.2	292	30 098 13.25	–
	100	4	17.5	31.5	3-7.2	292	30 098 13.31,5	–
				40	3-7.2	292	30 098 13.40	–
125	4	21.87	31.5	3-7.2	292	30 098 13.31,5	–	
			40	3-7.2	292	30 098 13.40	–	
160	4	28	40	3-7.2	292	30 098 13.40	–	
			50	3-7.2	292	30 098 13.50	–	
200	4	35	50	3-7.2	292	30 098 13.50	–	
			63	3-7.2	292	30 099 13.63	–	
250	4	43.74	63	3-7.2	292	30 099 13.63	–	
			80	3-7.2	292	30 099 13.80	–	
4.16-4.8	20	4	2.78	6.3	3-7.2	292	30 098 13.6,3	–
				10	3-7.2	292	30 098 13.10	–
	30	4	4.16	10	3-7.2	292	30 098 13.10	–
				16	3-7.2	292	30 098 13.16	–
	50	4	6.93	16	3-7.2	292	30 098 13.16	–
				20	3-7.2	292	30 098 13.20	–
	75	4	10.4	16	3-7.2	292	30 098 13.16	–
				20	3-7.2	292	30 098 13.20	–
	100	4	13.87	20	3-7.2	292	30 098 13.20	–
				25	3-7.2	292	30 098 13.25	–
125	4	17.35	25	3-7.2	292	30 098 13.25	–	
			31.5	3-7.2	292	30 098 13.31,5	–	
160	4	22.2	31.5	3-7.2	292	30 098 13.31,5	–	
			40	3-7.2	292	30 098 13.40	–	
200	4	27.75	40	3-7.2	292	30 098 13.40	–	
			50	3-7.2	292	30 098 13.50	–	
250	4	34.7	50	3-7.2	292	30 098 13.50	–	
			63	3-7.2	292	30 099 13.63	–	
315	4	43.7	63	3-7.2	292	30 099 13.63	–	
			80	3-7.2	292	30 099 13.80	–	
5.0-5.5	20	4	2.3	6.3	3-7.2	292	30 098 13.6,3	–
				10	3-7.2	292	30 098 13.6,3	–
	30	4	3.4	6.3	3-7.2	292	30 098 13.6,3	–
				10	3-7.2	292	30 098 13.10	–
	50	4	5.7	10	3-7.2	292	30 098 13.10	–
				16	3-7.2	292	30 098 13.16	–
	75	4	8.6	16	3-7.2	292	30 098 13.16	–
				20	3-7.2	292	30 098 13.20	–
	100	4	11.5	16	3-7.2	292	30 098 13.16	–
				20	3-7.2	292	30 098 13.20	–
	125	4	14.4	20	3-7.2	292	30 098 13.20	–
				25	3-7.2	292	30 098 13.25	–
	160	4	18.4	31.5	3-7.2	292	30 098 13.31,5	–
				40	3-7.2	292	30 098 13.40	–
200	4	23	40	3-7.2	292	30 098 13.40	–	
			50	3-7.2	292	30 098 13.50	–	
250	4	28.8	40	3-7.2	292	30 098 13.40	–	
			50	3-7.2	292	30 098 13.50	–	
315	4	36.3	50	3-7.2	292	30 098 13.50	–	
			63	3-7.2	292	30 099 13.63	–	
400	4	46.1	63	3-7.2	292	30 099 13.63	–	
			80	3-7.2	292	30 099 13.80	–	

Allocation of HV HRC fuses and transformer ratings

System operating voltage U_n kV	Transformer			HV HRC fuse			Make Siba	Make Mersen
	Rated power S_N kVA	Relative impedance voltage u_k %	Rated current I_1 A	Rated current of fuse I_{fuse} A	Operating voltage U_{fuse} kV	Dimension e mm	Order No.	Order No.
6-7.2	20	4	1.9	6.3	6-12	292	30 004 13.6,3	–
				6.3	3-7.2	292	30 098 13.6,3	–
				6.3	6-12	442	30 101 13.6,3	–
	50	4	4.8	10	3-7.2	292	30 098 13.10	–
				10	6-12	292	30 004 13.10	–
				10	6-12	442	30 101 13.10	–
				16	3-7.2	292	30 098 13.16	–
				16	6-12	292	30 004 13.16	45DB120V16PTS2
				16	6-12	442	30 101 13.16	–
	75	4	7.2	16	3-7.2	292	30 098 13.16	–
				16	6-12	292	30 004 13.16	45DB120V16PTS2
				16	6-12	442	30 101 13.16	–
	100	4	9.6	16	3-7.2	292	30 098 13.16	–
				16	6-12	292	30 004 13.16	–
				16	6-12	442	30 101 13.16	–
				20	3-7.2	292	30 098 13.20	–
				20	6-12	292	30 004 13.20	–
				20	6-12	442	30 101 13.20	–
				25	6-12	292	–	45DB120V25PTS2
	125	4	12	20	3-7.2	292	30 098 13.20	–
				20	6-12	292	30 004 13.20	–
				20	6-12	442	30 101 13.20	–
				25	3-7.2	292	30 098 13.25	–
				25	6-12	292	30 004 13.25	45DB120V25PTS2
				25	6-12	442	30 101 13.25	–
	160	4	15.4	31.5	3-7.2	292	30 098 13.31,5	–
				31.5	6-12	292	30 004 13.31,5	45DB120V32PTS2
				31.5	6-12	442	30 101 13.31,5	–
	200	4	19.2	31.5	3-7.2	292	30 098 13.31,5	–
				31.5	6-12	292	30 004 13.31,5	–
				31.5	6-12	442	30 101 13.31,5	–
				40	3-7.2	292	30 098 13.40	–
				40	6-12	292	30 004 13.40	45DB120V40PTS2
	250	4	24	40	6-12	442	30 101 13.40	–
				40	3-7.2	292	30 098 13.40	–
				40	6-12	292	30 004 13.40	–
				40	6-12	442	30 101 13.40	–
				50	3-7.2	292	30 098 13.50	–
				50	6-12	292	30 004 13.50	–
				50	6-12	442	30 101 13.50	–
	315	4	30.3	63	6-12	292	30 012 43.63	45DB120V63PTS2
				50	3-7.2	292	30 098 13.50	–
50				6-12	292	30 004 13.50	45DB120V50PTS2	
50				6-12	442	30 101 13.50	–	
63				6-12	292	30 012 43.63	45DB120V63PTS2	
400	4	38.4	80	6-12	292	–	45DB120V80PTS2	
			63	6-12	292	30 012 43.63	–	
			80	6-12	292	30 012 43.80	45DB120V80PTS2	
			80	6-12	442	30 102 43.80	–	
			63	3-7.2	292	30 099 13.63	–	
			63	6-12	292	30 012 13.63	–	
			63	6-12	442	30 102 13.63	–	
500	4	48	100	6-12	292	–	45DB120V100PTS2	
			80	6-12	292	30 012 43.80	–	
			80	6-12	442	30 102 43.80	–	
			80	3-7.2	292	30 099 13.80	–	
			80	6-12	292	30 012 13.80	–	
630	4	61	80	6-12	442	30 102 13.80	–	
			100	6-12	292	30 012 43.100	45DB120V100PTS2	
			100	6-12	442	30 102 43.100	45DB120V100PTS3	
			125	6-12	292	30 020 43.125	45DB120V125PTS2	
			125	6-12	442	30 103 43.125	–	
800	4	77	160	6-12	292	–	45DB120V160PTS3	
10-12	20	4	1.15	4	6-12	292	30 004 13.4	–
				10	6-12	292	30 004 13.10	45DB120V10PTS2
	50	4	2.9	10	6-12	442	30 101 13.10	–
				10	10-17.5	292	30 255 13.10	–
				10	10-17.5	442	30 231 13.10	–
				10	10-24	442	30 006 13.10	45DB240V10PTD
				10	10-24	442	30 006 13.10	45DB240V10PTD
	75	4	4.3	10	6-12	292	30 004 13.10	45DB120V10PTD
				10	6-12	442	30 101 13.10	–
				10	10-17.5	292	30 255 13.10	–
				10	10-17.5	442	30 231 13.10	–
				10	10-24	442	30 006 13.10	45DB240V10PTD
10				10-24	442	30 006 13.10	45DB240V10PTD	

Components

Allocation of HV HRC fuses and transformer ratings

System operating voltage U_n kV	Transformer			HV HRC fuse			Make Siba	Make Mersen
	Rated power S_N kVA	Relative impedance voltage u_k %	Rated current I_1 A	Rated current of fuse I_{fuse} A	Operating voltage U_{fuse} kV	Dimension e mm	Order No.	Order No.
10-12	100	4	5.8	16	6-12	292	30 004 13.16	–
				16	6-12	442	30 101 13.16	–
				16	10-17.5	292	30 255 13.16	–
				16	10-17.5	442	30 231 13.16	–
	125	4	7.2	16	10-24	442	30 006 13.16	45DB240V16PTD
				16	6-12	292	30 004 13.16	45DB120V16PTD
				16	6-12	442	30 101 13.16	–
				16	10-17.5	292	30 255 13.16	–
				16	10-17.5	442	30 231 13.16	–
				16	10-24	442	30 006 13.16	45DB240V16PTD
				20	10-24	442	–	45DB240V20PTD
				20	10-24	442	–	45DB240V20PTD
	160	4	9.3	20	6-12	292	30 004 13.20	45DB120V20PTD
				20	6-12	442	30 101 13.20	–
				20	10-17.5	292	30 221 13.20	–
				20	10-17.5	442	30 231 13.20	–
				20	10-24	442	30 006 13.20	45DB240V20PTD
	200	4	11.5	25	6-12	292	30 004 13.25	45DB120V25PTD
				25	6-12	442	30 101 13.25	–
				25	10-17.5	292	30 221 13.25	–
				25	10-17.5	442	30 231 13.25	–
				25	10-24	442	30 006 13.25	45DB240V25PTD
	250	4	14.5	25	6-12	292	30 004 13.25	45DB120V25PTD
				25	6-12	442	30 101 13.25	–
				25	10-17.5	292	30 221 13.25	–
				25	10-17.5	442	30 231 13.25	–
				25	10-24	442	30 006 13.25	45DB240V25PTD
				31.5	6-12	292	30 004 13.31,5	–
				31.5	6-12	442	30 101 13.31,5	–
				31.5	10-17.5	292	30 221 13.31,5	–
				31.5	10-17.5	442	30 231 13.31,5	–
				31.5	10-24	442	30 006 13.31,5	45DB240V32PTD
				315	4	18.3	31.5	6-12
	31.5	6-12	442				30 101 13.31,5	–
	31.5	10-17.5	292				30 221 13.31,5	–
	31.5	10-17.5	442				30 231 13.31,5	–
	31.5	10-24	442				30 006 13.31,5	45DB240V32PTD
	40	6-12	292				30 004 13.40	–
	40	6-12	442				30 101 13.40	–
	40	10-17.5	292				30 221 13.40	–
	40	10-17.5	442				30 231 13.40	–
	40	10-24	442				30 006 13.40	45DB240V40PTD
	400	4	23.1				40	6-12
				40	6-12	442	30 101 13.40	–
				40	10-17.5	292	30 221 13.40	–
				40	10-17.5	442	30 231 13.40	–
				40	10-24	442	30 006 13.40	45DB240V40PTD
				50	6-12	292	30 004 13.50	–
				50	6-12	442	30 101 13.50	–
				50	10-17.5	292	30 221 13.50	–
				50	10-17.5	442	30 232 13.50	–
				50	10-24	442	30 014 13.50	45DB240V50PTS
				500	4	29	50	6-12
	50	6-12	442				30 101 13.50	–
50	10-17.5	292	30 221 13.50				–	
50	10-17.5	442	30 232 13.50				–	
50	10-24	442	30 014 13.50				45DB240V50PTD	
63	6-12	292	30 012 43.63				45DB120V63PTS2	
63	10-24	442	30 014 43.63				45DB240V63PTD	
63	10-24	442	–				–	
630	4	36.4	63	6-12	292	30 012 43.63	–	
			80	10-24	442	30 014 43.80	45DB240V80PTS	
			63	6-12	292	30 012 13.63	–	
			63	6-12	442	30 102 13.63	45DB120V63PTD	
			63	10-17.5	442	30 232 13.63	–	
			80	6-12	292	30 012 43.80	–	
			80	6-12	442	30 102 43.80	45DB120V80PTS2	
800	5 to 6	46.2	63	6-12	292	30 012 13.63	–	
			80	6-12	292	30 012 43.80	45DB120V80PTS2	
			80	6-12	442	30 102 43.80	–	
			80	10-24	442	–	45DB240V80PTS	
1000	5 to 6	58	100	6-12	292	–	45DB120V100PTS2	
			100	6-12	442	30 102 43.100	45DB120V100PTS3	
			100	10-24	442	–	45DB240V100PTS	
1250	5 to 6	72.2	125	6-12	292	–	45DB120V125PTS2	
			125	6-12	442	30 103 43.125	45DB120V125PTS3	
			125	10-24	442	–	45DB240V125PTS	

Allocation of HV HRC fuses and transformer ratings

System operating voltage U_n kV	Transformer			HV HRC fuse			Make Siba	Make Mersen
	Rated power S_N kVA	Relative impedance voltage u_k %	Rated current I_1 A	Rated current of fuse I_{fuse} A	Operating voltage U_{fuse} kV	Dimension e mm	Order No.	Order No.
13.8	20	4	0.8	3.15	10-24	442	30 006 13.3,15	–
	50	4	2.1	6.3	10-17.5	442	30 231 13.6,3	–
				6.3	10-24	442	30 006 13.6,3	–
				10	10-24	442	--	45DB240V10PTD
	75	4	3.2	6.3	10-17.5	442	30 231 13.6,3	–
				10	10-17.5	442	30 231 13.10	–
				10	10-24	442	30 006 13.10	45DB240V10PTD
	100	4	4.2	10	10-17.5	442	30 231 13.10	–
				16	10-17.5	442	30 231 13.16	–
				16	10-24	442	30 006 13.16	45DB240V16PTD
	125	4	5.3	10	10-17.5	442	30 231 13.10	–
				16	10-17.5	442	30 231 13.16	–
				16	10-24	442	30 006 13.16	45DB240V16PTD
	160	4	6.7	16	10-17.5	442	30 231 13.16	–
				16	10-24	442	–	45DB240V16PTD
	200	4	8.4	16	10-17.5	442	30 231 13.16	–
				20	10-17.5	442	30 231 13.20	–
				20	10-24	442	30 006 13.20	45DB240V20PTD
	250	4	10.5	20	10-17.5	442	30 231 13.20	–
				25	10-17.5	442	30 231 13.25	–
			25	10-24	442	30 006 13.25	45DB240V25PTD	
315	4	13.2	25	10-17.5	442	30 231 13.25	–	
			25	10-24	442	–	45DB240V25PTD	
			31.5	10-17.5	442	30 231 13.31,5	–	
			31.5	10-24	442	30 006 13.31,5	45DB240V32PTD	
400	4	16.8	31.5	10-17.5	442	30 231 13.31,5	–	
			31.5	10-24	442	30 006 13.31,5	45DB240V32PTD	
			40	10-24	442	–	45DB240V40PTD	
500	4	21	40	10-17.5	442	30 231 13.40	–	
			40	10-24	442	30 006 13.40	45DB240V40PTD	
			50	10-24	442	–	45DB240V50PTD	
630	4	26.4	50	10-17.5	442	30 232 13.50	–	
			50	10-24	442	30 014 13.50	45DB240V50PTD	
			63	10-24	442	–	45DB240V63PTD	
			80	10-24	442	–	45DB240V80PTS	
800	5 to 6	33.5	63	10-24	442	30 014 43.63	45DB240V63PTD	
			80	10-24	442	–	45DB240V80PTS	
1000	5 to 6	41.9	80	10-24	442	30 014 43.80	45DB240V80PTD	
1250	5 to 6	52.3	100	10-24	442	–	45DB240V100PTS	
15-17.5	20	4	0.77	3.15	10-24	442	30 006 13.3,15	–
	50	4	1.9	6.3	10-17.5	442	30 231 13.6,3	–
				6.3	10-24	442	30 006 13.6,3	–
	75	4	2.9	6.3	10-17.5	442	30 231 13.6,3	–
				10	10-24	442	–	45DB240V10PTD
	100	4	3.9	10	10-17.5	442	30 231 13.10	–
				10	10-24	442	–	45DB240V10PTD
	125	4	4.8	16	10-17.5	442	30 231 13.16	–
				16	10-24	442	30 006 13.16	45DB240V16PTD
	160	4	6.2	16	10-17.5	442	30 231 13.16	–
				16	10-24	442	–	45DB240V16PTD
	200	4	7.7	16	10-24	442	–	45DB240V16PTD
				20	10-17.5	442	30 231 13.20	–
				20	10-24	442	30 006 13.20	–
	250	4	9.7	25	10-17.5	442	30 231 13.25	–
				25	10-24	442	30 006 13.25	45DB240V25PTD
	315	4	12.2	25	10-24	442	–	45DB240V25PTD
				31.5	10-17.5	442	30 231 13.31,5	–
				31.5	10-24	442	30 006 13.31,5	–
	400	4	15.5	31.5	10-17.5	442	30 231 13.31,5	–
			31.5	10-24	442	30 006 13.31,5	45DB240V32PTD	
500	4	19.3	31.5	10-17.5	442	30 231 13.31,5	–	
			31.5	10-24	442	30 006 13.31,5	–	
			40	10-17.5	442	30 231 13.40	–	
			40	10-24	442	30 006 13.40	45DB240V40PTD	
630	4	24.3	40	10-17.5	442	30 231 13.40	–	
			40	10-24	442	30 006 13.40	–	
			50	10-17.5	442	30 232 13.50	–	
			50	10-24	442	30 014 13.50	45DB240V50PTD	
			63	10-24	442	30 014 43.63	–	
800	5 to 6	30.9	63	10-24	442	30 014 43.63	–	
1000	5 to 6	38.5	80	10-24	442	30 014 43.80	–	
1250	5 to 6	48.2	100	10-24	442	30 022 43.100	–	

Components

Allocation of HV HRC fuses and transformer ratings

System operating voltage U_n kV	Transformer			HV HRC fuse			Make Siba	Make Mersen
	Rated power S_N kVA	Relative impedance voltage u_k %	Rated current I_1 A	Rated current of fuse I_{fuse} A	Operating voltage U_{fuse} kV	Dimension e mm	Order No.	Order No.
20-24	20	4	0.57	3.15	10-24	442	30 006 13.3,15	–
	50	4	1.5	6.3	10-24	442	30 006 13.6,3	–
	75	4	2.2	6.3	10-24	442	30 006 13.6,3	–
	100	4	2.9	6.3	10-24	442	30 006 13.6,3	–
				10	10-24	442	–	45DB240V10PTD
	125	4	3.6	10	10-24	442	30 006 13.10	45DB240V10PTD
	160	4	4.7	10	10-24	442	30 006 13.10	–
	200	4	5.8	16	10-24	442	30 006 13.16	45DB240V16PTD
	250	4	7.3	16	10-24	442	30 006 13.16	45DB240V16PTD
	315	4	9.2	16	10-24	442	30 006 13.16	–
				20	10-24	442	30 006 13.20	–
				25	10-24	442	–	45DB240V25PTD
	400	4	11.6	20	10-24	442	30 006 13.20	–
				25	10-24	442	30 006 13.25	45DB240V25PTD
	500	4	14.5	25	10-24	442	30 006 13.25	45DB240V25PTD
				31.5	10-24	442	30 006 13.31,5	45DB240V32PTD
	630	4	18.2	31.5	10-24	442	30 006 13.31,5	45DB240V32PTD
				40	10-24	442	30 006 13.40	45DB240V40PTD
	800	5 to 6	23.1	31.5	10-24	442	30 006 13.31,5	–
				40	10-24	442	30 006 13.40	45DB240V40PTD
1000	5 to 6	29	50	10-24	442	30 014 13.50	45DB240V50PTS	
			63	10-24	442	30 014 43.63	–	
1250	5 to 6	36	50	10-24	442	–	45DB240V50PTS	
			80	10-24	442	30 014 43.80	–	
1600	5 to 6	46.5	100	10-24	442	30 022 43.100	–	
2000	5 to 6	57.8	140	10-24	442	30 022 43.140	–	

Features

- According to IEC/EN 61869-1 and -2/ VDE 0414-9-1 and -2
- Designed as ring-core current transformers, 1-pole
- Free of dielectrically stressed cast-resin parts (due to design)
- Insulation class E
- Inductive type
- Secondary connection by means of a terminal strip in the panel.

Installation

The mounting location is outside the switchgear vessel, around the cable at the panel connection; installation on the cable on site.

Note: Installation inside or underneath the panel depending on the panel type and the overall transformer height.

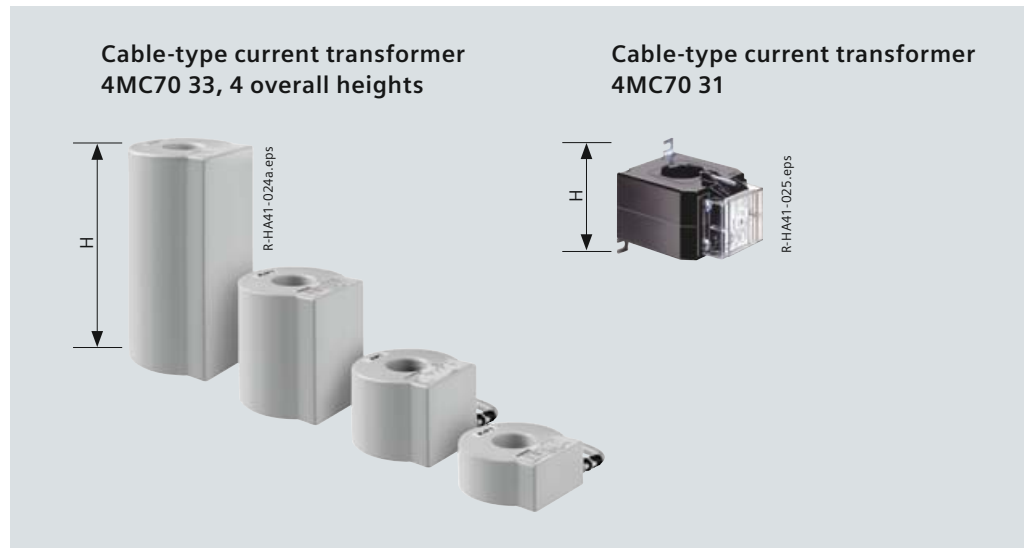

Technical data

Cable-type current transformer 4MC70 33

Primary data

Highest voltage for equipment U_m	0.72 kV
Rated current I_N	20 A to 600 A
Rated short-duration power-frequency withstand voltage (winding test)	3 kV
Rated short-time thermal current I_{th}	up to 25 kA/1 s or 20 kA/3 s
Rated continuous thermal current I_D	$1.2 \times I_N$
Transient overload current	$1.5 \times I_D/1$ h or $2 \times I_D/0.5$ h
Rated dynamic current I_{dyn}	$2.5 \times I_{th}$

Secondary data

Rated current	1 A or 5 A, optionally: multiratio			
Measuring core	Class	0.2	0.5	1
	Overcurrent factor	without	FS5	FS10
	Rating	2.5 VA to 30 VA		
Protection core	Class	10 P	5 P	
	Overcurrent factor	10	20	30
	Rating	1 VA to 30 VA		

Dimensions

Overall height H, depending on core data	mm	65	110	170	285
Outside diameter		150 mm			
Inside diameter		55 mm			
For cable diameter		50 mm			

Other values on request

Technical data

Cable-type current transformer 4MC70 31

Primary data

Highest voltage for equipment U_m	0.72 kV
Rated current I_N	50 A to 600 A
Rated short-duration power-frequency withstand voltage (winding test)	3 kV
Rated short-time thermal current I_{th}	up to 25 kA/1 s or 14.5 kA/3 s
Rated continuous thermal current I_D	$1.2 \times I_N$
Transient overload current	$1.5 \times I_D/1$ h or $2 \times I_D/0.5$ h
Rated dynamic current I_{dyn}	$2.5 \times I_{th}$

Secondary data

Rated current	1 A or 5 A	
Measuring core	Class	1
	Overcurrent factor	FS5
	Rating	2.5 VA to 10 VA

Dimensions

Overall height H	89 mm
Width x depth	85 mm x 114 mm
Inside diameter	40 mm
For cable diameter	36 mm

Other values on request

Components

Three-phase current transformer 4MC63

Features

- According to IEC/EN 61869-1 and -2/ VDE 0414-9-1 and -2
- Designed as ring-core current transformer, 3-pole
- Free of dielectrically stressed cast-resin parts (due to design)
- Insulation class E
- Inductive type
- Climate-independent
- Secondary connection by means of a terminal strip in the panel.

Installation

- Mounting location:
 - For individual panels type R(500) and L(500) (optional)
 - Arranged outside the switchgear vessel on the bushings of the cable connection
 - Factory-assembled.

Further designs (option)

For protection equipment based on the current-transformer operation principle:

- Protection system 7SJ45 as definite-time overcurrent protection
- Definite-time overcurrent protection relay, make Woodward/SEG, type WIP 1
- Definite-time overcurrent protection relay, make Woodward/SEG, type WIC.

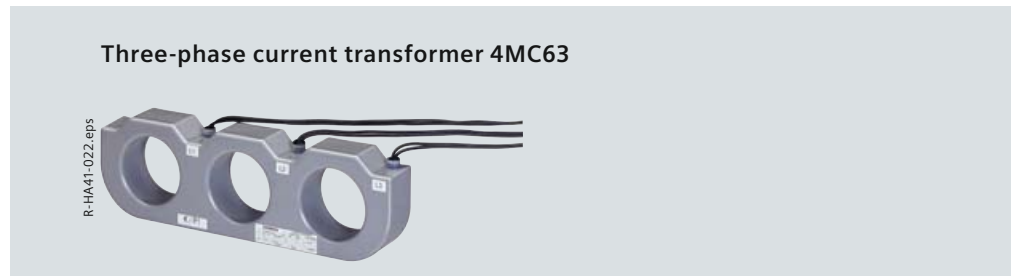

Technical data

Three-phase current transformer 4MC63 10
for $I_N \leq 150$ A and $I_D = 630$ A

Primary data

Highest voltage for equipment U_m	0.72 kV
Rated current I_N	A 150 100 75 50
Rated short-duration power-frequency withstand voltage (winding test)	3 kV
Rated short-time thermal current I_{th}	up to 25 kA/1 s or 20 kA/3 s
Rated continuous thermal current I_D	630 A
Transient overload current	$1.5 \times I_D/1$ h
Rated dynamic current I_{dyn}	$2.5 \times I_{th}$

Secondary data

Rated current	A	1	0.67	0.5	0.33
Rating	VA	2.5	1.7	1.25	0.8
Current at I_D		4.2 A			
Protection core	Class	10 P			
	Overcurrent factor	10			

Other values on request

Technical data

Three-phase current transformer 4MC63 11
for $I_N \leq 400$ A and $I_D = 630$ A

Primary data

Highest voltage for equipment U_m	0.72 kV
Rated current I_N	A 400 300 200
Rated short-duration power-frequency withstand voltage (winding test)	3 kV
Rated short-time thermal current I_{th}	up to 25 kA/1 s or 20 kA/3 s
Rated continuous thermal current I_D	630 A
Transient overload current	$2 \times I_D/0.5$ h
Rated dynamic current I_{dyn}	$2.5 \times I_{th}$

Secondary data

Rated current	A	1	0.75	0.5
Rating	VA	4	3	2
Current at I_D		1.575 A		
Protection core	Class	10 P		
	Overcurrent factor	10		

Other values on request

Features

- According to IEC/EN 61869-1 and -2/ VDE 0414-9-1 and -2
- Designed as ring-core current transformer, 1-pole
- Free of dielectrically stressed cast-resin parts (due to design)
- Insulation class E
- Inductive type
- Secondary connection by means of a terminal strip in the panel.

Installation

- Mounting location:
 - Arranged outside the switchgear vessel on the screened busbar section in bus sectionalizer panels type S and V with the option of busbar current transformers
 - Arranged outside the switchgear vessel around the cable at the panel connection for 310 mm panel width (cable feeders type R and K), transformers mounted on a supporting plate at the factory; final assembly around the cables on site.

Note: Depending on the transformer overall height: Installation inside or underneath the panel.

Bus / cable-type current transformer 4MC70 32

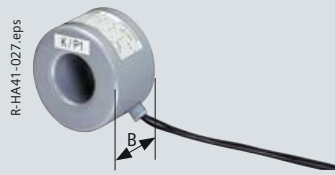

Technical data

Bus / cable-type current transformer 4MC70 32

Primary data

Highest voltage for equipment U_m	0.72 kV
Rated current I_N	200 A to 600 A
Rated short-duration power-frequency withstand voltage (winding test)	3 kV
Rated short-time thermal current I_{th}	up to 25 kA/1 s or 20 kA/3 s
Rated continuous thermal current I_D	$1.2 \times I_N$
Transient overload current	$1.5 \times I_D/1 \text{ h}$ or $2 \times I_D/0.5 \text{ h}$
Rated dynamic current I_{dyn}	$2.5 \times I_{th}$

Secondary data

Rated current	1 A (option: 5 A)			
Measuring core	Class	0.2	0.5	1
	Overcurrent factor	without	FS5	FS10
	Rating	2.5 VA to 10 VA		
Protection core	Class	10 P	5 P *)	
	Overcurrent factor	10	10	
	Rating	2.5 VA to 15 VA		

Dimensions

Overall width B, depending on core data and mounting location	80 mm/150 mm
Outside diameter	125 mm
Inside diameter	55 mm

Other values on request *) On request

Panel section type V

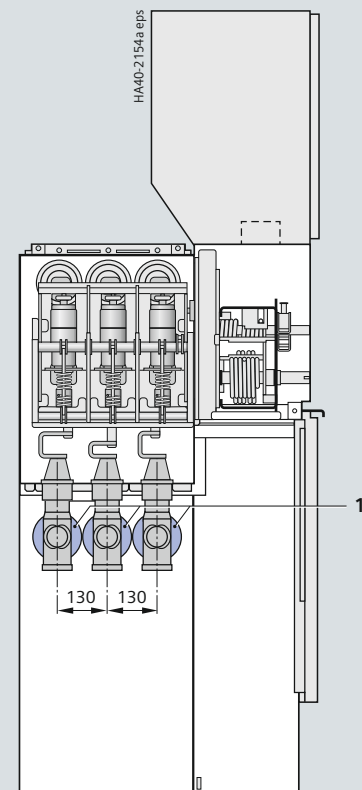

1 Bus / cable-type current transformer 4MC70 32

Components

Plug-in voltage transformers 4MT3 and 4MT8

Common features

- According to IEC/EN 61869-1 and -3/ VDE 0414-9-1 and -3
- 1-pole, plug-in design
- Inductive type
- Connection with plug-in contact
- Safe-to-touch due to metal cover
- Secondary connection by means of plugs inside the panel.

Features of type 4MT3

- Metal-coated or metal-enclosed (option)
- For outside-cone system type A.

Installation

- Mounting location:
 - Arranged above the switchgear vessel in individual panels type L(500), M(430), V and E (optional)
 - Arranged in front of the switchgear vessel in individual panel type M(500)
 - Direct connection to the busbar.

Features of type 4MT8

- Metal-enclosed
- For connection to the cable plug-in unit (screened).

Installation

- Mounting location:
 - Arranged in the cable compartment of individual panels type L(500) and R(500) (optional).



Technical data

for types 4MT3 *) and 4MT8 *)

Primary data

Highest voltage for equipment $1.2 \times U_n$		
Rated voltage (8 h) = $1.9 \times U_n$		
Rated voltage U_r	Operating voltage U_n	
kV	kV / $\sqrt{3}$	
3.6	3.3	
7.2	3.6	
	4.2	
	4.8	
	5.0	
	6.0	
	6.3	
	6.6	
12	7.2	
	10.0	
	11.0	
	11.6	
	12.8	
17.5	13.2	
	13.8	
	15.0	
	16.0	
	24	17.5
		20.0
22.0		
23.0		

Technical data

Secondary data

Rated voltage	1 st winding	$100/\sqrt{3}$ $110/\sqrt{3}$
	Auxiliary winding (option)	100/3 110/3

for 4MT3

Rated long-time current (8 h)	6 A	Class
Rating in VA up to	20	0.2
	60	0.5
	120	1.0

for 4MT8

Rated long-time current (8 h)	6 A	Class
Rating in VA up to	25	0.2
	75	0.5
	120	1.0

Combination of voltage transformers 4MT8 *) with cable T-plugs (without deep cable compartment cover)

Make	Type	Design	Make	Type	Design
Nexans	(K) 400 TB/G (K) 440 TB/G	Screened	Südkabel	SEHDT (13/23) without metal enclosure	Screened
Prysmian	FMCTs-400	Screened			

*) Removal required for dielectric test of switchgear on site (max. 80 % U_d)

Current transformers 4MA7 and voltage transformers 4MR for air-insulated billing metering panels

Features

Current transformer 4MA7

- According to IEC/EN 61869-1 and -2/ VDE 0414-9-1 and -2
- Dimensions according to DIN 42600-8 (small design)
- Designed as indoor support-type current transformer, 1-pole
- Cast-resin insulated
- Insulation class E
- Secondary connection by means of screw-type terminals.

Voltage transformer 4MR

- According to IEC/EN 61869-1 and -3/ VDE 0414-9-1 and -3
- Dimensions according to DIN 42600-9 (small design)
- Designed as indoor voltage transformer:
 - Type 4MR, 1-pole
 - Option: Type 4MR, 2-pole
- Cast-resin insulated
- Insulation class E
- Secondary connection by means of screw-type terminals.

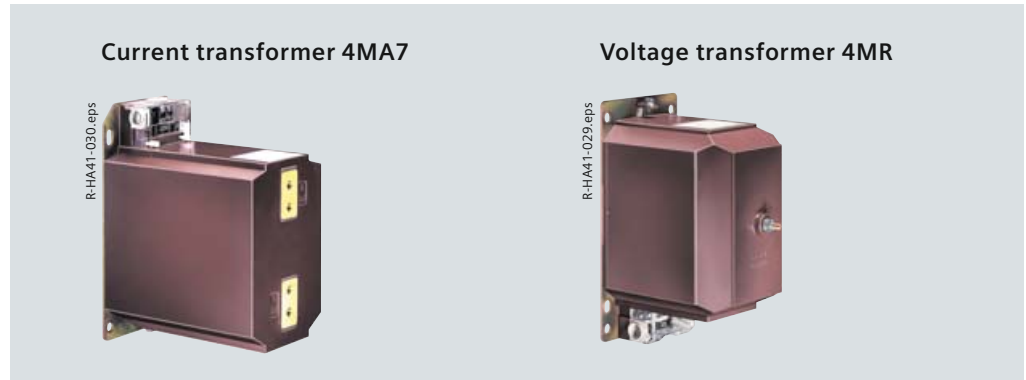

Technical data

Current transformer 4MA7, 1-pole

Primary data

Highest voltage for equipment U_m	up to 24 kV
Rated short-duration power-frequency withstand voltage U_d	up to 50 kV
Rated lightning impulse withstand voltage U_p	up to 125 kV
Rated current I_N	20 A to 600 A
Rated short-time thermal current I_{th}	up to 25 kA/1 s
Rated continuous thermal current I_D	$1.2 \times I_N$
Rated dynamic current I_{dyn}	max. $2.5 \times I_{th}$

Secondary data

Rated current	1 A or 5 A		
Measuring core	Class	0.2	0.5 1
	Overcurrent factor	without	FS5 FS10
	Rating	2.5 VA to 30 VA	
Protection core	Class	5 P or 10 P	
	Overcurrent factor	10	
	Rating	2.5 VA to 30 VA	

Other values on request

Technical data

Voltage transformer 4MR, 1-pole

Primary data

Highest voltage for equipment $1.2 \times U_n$	
Rated voltage (8 h) = $1.9 \times U_n$	
Rated voltage U_r	Operating voltage U_n
kV	kV/ $\sqrt{3}$
3.6	3.3
7.2	3.6
	4.2
	4.8
	5.0
	6.0
	6.3
	6.6
12	7.2
	10.0
	11.0
	11.6
17.5	12.8
	13.2
	13.8
	15.0
	16.0
24	17.5
	20.0
	22.0
	23.0

Secondary data

Rated voltage in V	1 st winding	100/ $\sqrt{3}$ 110/ $\sqrt{3}$ 120/ $\sqrt{3}$	
	Auxiliary winding (option)	100/3 110/3 120/3	
Rating in VA up to		Class	
		20	0.2
		60	0.5
	100	1.0	

Other values on request

Components

Current sensors

Common features

- According to IEC 61869-8 (current sensors)
- Example for available secondary devices that can be connected:
 - SICAM FCM
 - 7SJ81

Current sensors

(make Zelisko)

The current sensors are inductive current transformers whose secondary winding delivers a voltage signal through a precision shunt. At the rated primary current, this is 225 mV. Depending on their version, the sensors have a dual accuracy class; the output signal can be equally used for measuring, protection and, if required, earth-fault detection. The outgoing leads of the sensors are directly connected to the secondary device (SICAM FCM, 7SJ81).



Technical data

	SMCS-JW1001	SMCS/T-JW1002	GAE120/SENS-JW1003	SMCS3-JW1004
--	-------------	---------------	--------------------	--------------

Primary data

Highest voltage for equipment U_n	0.72/3 kV	0.72/3 kV	0.72/3 kV	0.72/3 kV
Rated current I_N	300 A ¹⁾	300 A ¹⁾	60 A	300 A ¹⁾
Rated short-time thermal current I_{th}	25 kA 1 s	25 kA 1 s	25 kA 1 s	25 kA 1 s

Secondary data

Output signal	225 mV	225 mV	225 mV	225 mV	
Measuring	Class	0.5; 1; 3	1; 3	0.5; 1; 3	
	Overcurrent factor	–	–	–	
Protection	Class	5P	5P	5P	
	Overcurrent factor	10 20	10; 20	–	10
Earth-fault detection	Class	–	–	1	1
	Angle error	–	–	± 120'	± 120'
	Composite error e	–	–	≤ 10 % (at 0.4 A) ≤ 20 % (at 200 A)	≤ 10 % (at 0.4 A)
Rated burden	≥ 20 kOhm	≥ 20 kOhm	≥ 20 kOhm	≥ 20 kOhm	

Dimensions and installation

Overall height, depending on the overcurrent factor	28 mm	up to 56 mm	53 mm	130 mm (incl. mounting plate)	54 mm
External dimensions in mm	128 x 106		111 x 106	242 x 226	300 x 132
Inside diameter in mm	82		55	120	84 (per phase)
Mounting location	Cable plug ²⁾		On the cable	On the cable	Cable plug ²⁾
Usable for panel widths in mm	310, 430, 500	430, 500	310, 430, 500	310, 430, 500	310

1) Usable up to $2 \times I_N = 600$ A (output signal 2×225 mV) at constant accuracy class and half overcurrent factor

2) Mounting location at the bushings around the screened cable plug

Common features

- According to IEC 61869-7 (voltage sensors)
- Example for available secondary devices that can be connected:
 - SICAM FCM
 - 7SJ81

Voltage sensors

(make Zelisko)

The voltage sensors are resistor dividers which provide an output signal of $3.25 V/\sqrt{3}$ at the rated primary voltage. The outgoing leads of the sensors are directly connected to the secondary device (SICAM FCM, 7SJ81).



Technical data

	SMVS-UW1001		SMVS-UW1002	
--	-------------	--	-------------	--

Primary data

Highest voltage for equipment U_m	1.2 x U_n		1.2 x U_n	
Rated voltage (8 h)	1.9 x U_n		1.9 x U_n	
Rated voltage U_r	12 kV	24 kV	12 kV	24 kV
Operating voltage U_n	10 kV	20 kV	10 kV	20 kV

Secondary data

Rated voltage	$3.25 V/\sqrt{3}$		$3.25 V/\sqrt{3}$	
Class	0.5; 1; 3		0.5; 1; 3	
Rated burden	200 kOhm \pm 1%		200 kOhm \pm 1%	

Installation

Mounting location	On the screened cable plugs make Nexans type 440TB, K440TB; other types and makes on request	On the screened cable plugs make TE Connectivity type RSTI-58, RSTI-CC58xx, make nkt cables type CB-24 and CC-24; other types and makes on request
-------------------	--	--

Components

Cable connection for feeders with bolted contact and outside cone type "C"

Features

- Access to the cable compartment only if the feeder has been disconnected and earthed
- Bushings according to DIN EN 50181 with outside cone and bolted connection M16 as interface type "C".

Connection of

- Cable elbow plugs or cable T-plugs with bolted contact M16 for 630 A
- Paper-insulated mass-impregnated cables via customary adapters
- Thermoplastic-insulated cables (1-core and 3-core cables).

Option

- Mounted cable clamps on cable bracket.

Cable plugs

- As screened (semi-conductive) design independent of the site altitude,
or
as unscreened (insulated) design, but then dependent on the site altitude.

Surge arresters

- Pluggable on cable T-plug, cable elbow plug or T-adaptor
- The switchgear depth can be extended when surge arresters are mounted (depending on the make and type)
- Surge arresters recommended if, at the same time,
 - the cable system is directly connected to the overhead line,
 - the protection zone of the surge arrester at the end tower of the overhead line does not cover the switch-gear.

Surge limiters

- Pluggable on cable T-plug
- Surge limiters recommended when motors with starting currents < 600 A are connected.

Cable compartment

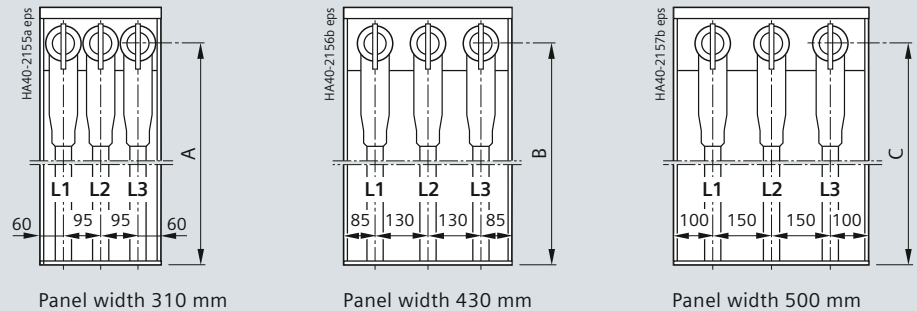

	Switchgear height without low-voltage compartment ¹⁾		1040 ²⁾	1200	1400 without absorber base	1400 with absorber base, or 1700
Panel width 310 mm	Typical K, R	A	500	660	860	1160
	Typical R (8DJH Compact)		–	–	200	500
Panel width 430 mm	Typical K(E), L	B	–	660	860	1160
Panel width 500 mm	Typical R(500), L(500)	C	–	510	710	1010

1) Option: With low-voltage compartment

2) Only for panel blocks RR, RRR, RT, RRT and RTR

Connection options

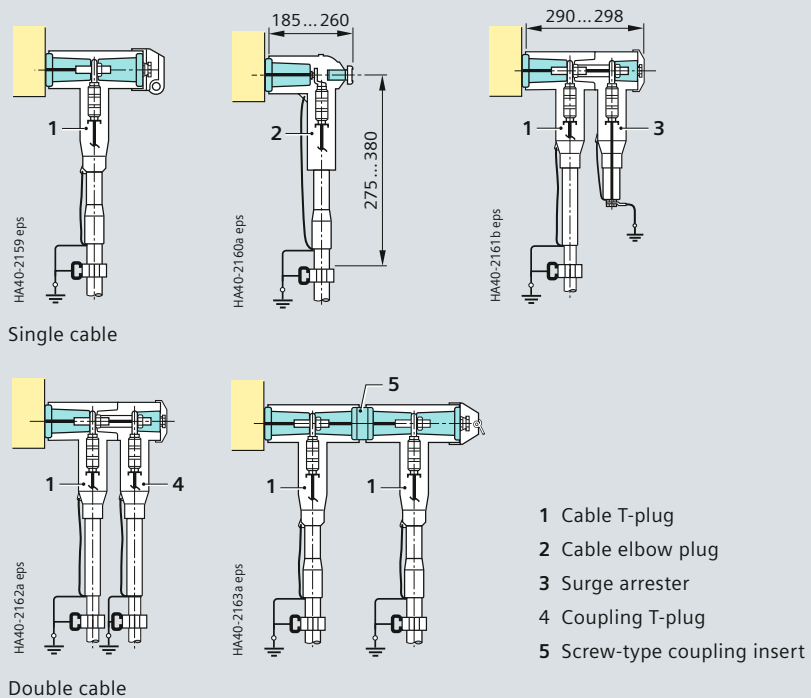

Cable plugs for feeders with bolted contact and outside cone type "C" (further types on request)

Cable type	Cable plugs					
	Make	Serial no.	Type	Design T/W ¹⁾	Conductor cross-section mm ²	Design ²⁾

Thermoplastic-insulated cables ≤ 12 kV according to IEC/EN 60502-2/VDE 0276-620

1-core or 3-core cable, PE and XLPE-insulated N2YSY (Cu) and N2XSY (Cu) or NA2YSY (Al) and NA2XSY (Al)	Nexans	1	400 TB/G, 430 TB-630	T	35–300	Screened
		2	400 LB/G	W	35–300	Screened
		3	440 TB/G	T	185–630	Screened
	nkt cables	4	CB 24-630	T	25–300	Screened
		5	AB 24-630	T	25–300	Insulated
		6	CB 36-630 (1,250)	T	300–630	Screened
	Südkabel	7	SET 12	T	50–300	Screened
		8	SEHDT 13	T	185–500	Screened
	Prysmian Kabel und Systeme (Pirelli Elektrik)	9	FMCTs-400	T	25–300	Screened
		3M	10	93-EE 705-6/-95	T	50–95
	11		93-EE 705-6/-240	T	95–240	Screened
	TE Connectivity	12	RICS 51 ... with IXSU	T	25–300	Insulated
		13	RICS 31 ... with IXSU	T	25–300	Insulated
		14	RSTI-39xx	T	400–800	Screened

Thermoplastic-insulated cables 15/17.5/24 kV according to IEC/EN 60502-2/VDE 0276-620

1-core or 3-core cable, PE and XLPE-insulated N2YSY (Cu) and N2XSY (Cu) or NA2YSY (Al) and NA2XSY (Al)	Nexans	15	K400 TB/G, 430 TB-630	T	35–300	Screened	
		16	K400 LB/G	W	35–300	Screened	
		17	K440 TB/G	T	185–630	Screened	
	nkt cables	18	CB 24-630	T	25–300	Screened	
		19	AB 24-630	T	25–300	Insulated	
		20	CB 36-630 (1,250)	T	300–630	Screened	
	Südkabel	21	SET 24	T	50–240	Screened	
		22	SEHDT 23.1	T	300	Screened	
		23	SEHDT 23	T	185–630	Screened	
	Prysmian Kabel und Systeme (Pirelli Elektrik)	24	FMCTs-400	T	25–240	Screened	
		3M	25	93-EE 705-6/-95	T	25–95	Screened
	26		93-EE 705-6/-240	T	95–240	Screened	
	TE Connectivity	for 1-core cables	27	RICS 51 ... with IXSU	T	25–300	Insulated
			28	RSTI-58xx	T	25–300	Screened
29			RSTI-59xx	T	400–800	Screened	
for 3-core cables		30	RICS 51 ... with IXSU	T	25–300	Insulated	
		31	RSTI-58xx + RSTI-TRFxx	T	25–300	Screened	

Paper-insulated mass-impregnated cables ≤ 12 kV according to IEC/EN 60055-2/VDE 0276-621

3-core cable as a belted cable, paper-insulated N(A)KBA: 6/10 kV	TE Connectivity	32	RICS 51... with UHGK/EPKT	T	95–300	Insulated
3-core cable as a sheathed cable, paper-insulat. N(A) EKEBA: 6/10 kV	TE Connectivity	33	RICS 51... with IDST 51 .. ³⁾	T	50–300	Insulated

Paper-insulated mass-impregnated cables 15/17.5/24 kV according to IEC/EN 60055-2/VDE 0276-621

1-core or 3-core cable, paper-insulated N(A)KLEY, N(A)KY or N(A)EKBA: 12/20 kV	TE Connectivity	34	RICS 51 ... with IDST 51 .. ³⁾	T	35–240	Insulated
--	-----------------	----	---	---	--------	-----------

1) T = Cable T-plug, W = Cable elbow plug

2) In connection with current transformers or sensors on the cable, use only screened systems.

3) Discontinued by the manufacturer

Components

Cable connection for single and double cables with surge arresters

To increase the mounting depth in the cable compartment, deep cable compartment covers can be ordered optionally (not for 8DJH Compact). The assignment to selected types of cable plugs and cable plug / surge arrester combinations is given in the following tables.

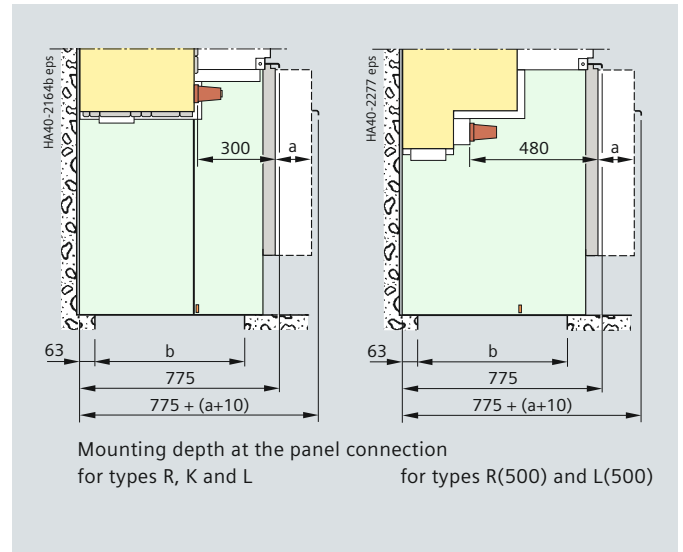

Double cable connection

Double cable connection			Connection combination			Deep cable compartment cover ¹⁾	
Make	Serial no.	Cable plug (type)	Design ²⁾	Arrangement	Mounting depth (mm)	Deeper by a (mm)	Depth of floor opening b (mm)
Nexans	1	430 TB + 300 PB-630A	Screened	K + K	290	–	635
	2	2x (K)400 TB/G with coupling insert (K)400 CP	Screened	K + K	505	250	860
	3	(K)400 TB/G + (K)400 LB/G with coupling insert (K)400 CP-LB	Screened	K + K	455	250	860
	4	(K)400 TB/G + 430 TB with coupling insert (K)400 CP	Screened	K + K	403	250	860
	5	2x (K)440 TB/G with coupling insert (K)440 CP	Screened	K + K	505	250	860
Südkabel	6	SET (12/24) + SEHDK (13.1/23.1)	Screened	K + K	290	–	635
	7	SEHDT 23.1 + SEHDK 23.1	Screened	K + K	290	–	635
	8	2x SEHDT 23.1 with coupling unit KU 23.2/23	Screened	K + K	363	250	860
	9	SEHDT (13/23) + SET (12/24) with coupling unit KU 23 or KU 33	Screened	K + K	451	250	860
	10	2x SET (12/24) with coupling unit KU 23.2/23	Screened	K + K	363	105	715
nkt cables	11	CB 24-630 + CC 24-630	Screened	K + K	290	–	635
	12	2x CB 24-630 with coupling unit CP 630C	Screened	K + K	370	250 105 o.r.	860 715
	13	AB 24-630 + AC 24-630	Insulated	K + K	290	105 o.r.	715
	14	2x AB 24-630 with coupling unit CP 630A	Insulated	K + K	370	250 105 o.r.	860 715
	15	CB 36-630 (1,250) + CC 36-630 (1,250)	Screened	K + K	300	–	635
TE Connectivity	16	RSTI-58xx + RSTI-CC-58xx	Screened	K + K	285	–	635
	17	RSTI-x9xx + RSTI-CC-x9xx	Screened	K + K	315	105	715
3M	18	2x 93-EE705-6/xxx with coupling unit KU 23.2	Screened	K + K	363	105	715

o.r. = on request

K = Cable plug

1) Applies to panels of 310 mm and 430 mm. For individual panels of 500 mm, no deep cable compartment cover and floor opening are required – except for serial no. 2 and no. 5 with cable compartment cover deeper by 105 mm (a).

2) In connection with current transformers or sensors on the cable, use only screened systems.

Cable connection for single and double cables with surge arresters

Single and double cable connection with surge arrester

Single and double cable connection with surge arrester			Connection combination			Deep cable compartment cover ¹⁾
Make	Serial no.	Cable plug / surge arrester (type)	Design ²⁾	Arrangement	Mounting depth (mm)	Deeper by a ³⁾ (mm)
Nexans	1	430 TB + 300 SA	Screened	K + Ü	290	–
	2	(K)400 TB/G + 400 PB-...SA	Screened	K + Ü	410	250
	3	430 TB + 300 PB + 300 SA	Screened	K + K + Ü	398	250
Südkabel	4	SET (12/24) + MUT (13/23)	Screened	K + Ü	302	105
	5	SEHDT 23.1 + MUT 23	Screened	K + Ü	302	105
	6	2x SET (12/24) + MUT (13/23) with coupling unit KU 23.2/23	Screened	K + K + Ü	476	250
	7	2x SEHDT 23.1 + MUT 23 with coupling unit KU 23.2/23	Screened	K + K + Ü	476	250
nkt cables	8	SEHDT (13/23) + MUT 33	Screened	K + Ü	540	250
	9	CB 24-630 + CSA 24...	Screened	K + Ü	290	–
	10	AB 24-630 + ASA 24...	Insulated	K + Ü	290	105
TE Connectivity	11	CB 36-630 (1,250) + CSA...	Screened	K + Ü	290	–
	12	RICS 5139 + RDA...	Insulated	K + Ü	275	–
	13	RSTI-58xx + RSTI-CC-58SAxx	Screened	K + Ü	285	–
	14	RSTI-58xx + RSTI-CC-68SAxx	Screened	K + Ü	292	–
	15	RSTI-x9xx + RSTI-CC-58SAxx	Screened	K + Ü	295	–
3M	16	RSTI-x9xx + RSTI-CC-68SAxx	Screened	K + Ü	302	105
	17	2x 93-EE705-6/xxx + MUT 23 with coupling unit KU 23.2	Screened	K + K + Ü	476	250

1) Applies to panels of 310- and 430-mm. For individual panels of 500 mm, no deep cable compartment cover and floor opening are required – except for serial no. 2 and no. 5 with cable compartment cover deeper by 105 mm (a).

2) In connection with current transformers or sensors on the cable, use only screened systems.

3) See drawing on page 46.

K = Cable plug Ü = Surge arrester

Components

Cable connection for transformer feeders with plug-in contact and outside cone type "A"

Features

- Access to the cable compartment only if the feeder has been disconnected and earthed
- Bushings according to DIN EN 50181 with outside cone and plug-in contact as interface type "A".

Connection of

- Cable elbow plugs or straight cable plugs
- Connection cross-sections up to 120 mm².

Option

- Mounted cable clamps on cable bracket
- Bushings according to DIN EN 50181 with outside cone and bolted contact as interface type "C" for cable routing downwards.

Routing of transformer cables

For 8DJH Standard design with bushing arrangement:

- At the front with cable elbow plug: Downwards (standard)
- At the bottom with cable elbow plug: To the rear (option)
- At the bottom with straight cable plug: Downwards (option).

For 8DJH Compact design with bushing arrangement:

- At the top with cable elbow plug: To the rear (standard)
- At the top with straight cable plug: Upwards (option)
- At the top with cable elbow plug: To the right (option).

Cable plugs

- As screened (semi-conductive) design independent of the site altitude,
or
as unscreened (insulated) design, but then dependent on the site altitude.

	Switchgear height without low-voltage compartment ¹⁾		1040 ²⁾	1200	1400 without absorber base	1400 with absorber base, or 1700
Panel width 430 mm	Typical T	A	62	222	422	722
	Typical T (8DJH Compact)	B ₁	–	–	1245	1545
		B ₂	–	–	1143	1443

Cable compartment

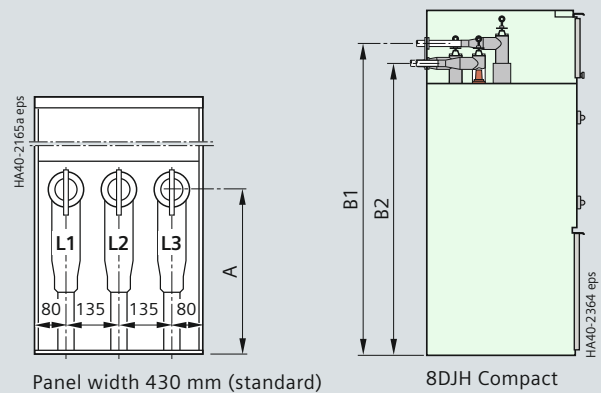

Connection options

8DJH Standard

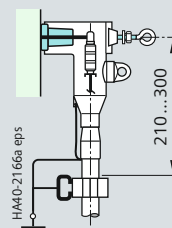

Cable routing downwards with cable elbow plug

8DJH Compact

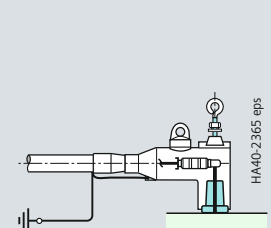

Cable routing to the rear with cable elbow plug

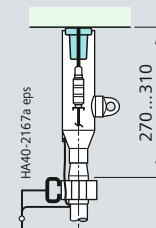

Cable routing downwards with straight plug

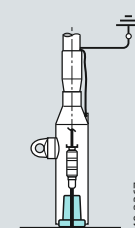

Cable routing upwards with straight plug

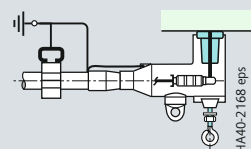

Cable routing to the rear with cable elbow plug

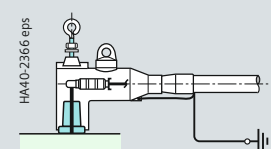

Cable routing to the right with cable elbow plug

1) Option: With low-voltage compartment

2) Only for panel blocks RR, RRR, RT, RRT and RTR

Cable plugs for transformer feeders with plug-in contact and outside cone type "A" (further types on request)

Cable type	Cable plug					
	Make	Serial no.	Type	Design G/W ¹⁾	Conductor cross-section mm ²	Design

Thermoplastic-insulated cables ≤ 12 kV according to IEC/EN 60502-2/VDE 0276-620

1-core cable, PE and XLPE-insulated N2YSY (Cu) and N2XSY (Cu) or NA2YSY (Al) and NA2XSY (Al)	Nexans	1	158 LR	W	16–120	screened; with capacitive measuring point
		2	152 SR	G	95–120	screened; with capacitive measuring point
	nkt cables	3	EASW 10/250, Gr. 2	W	25–95	screened; <u>option</u> : with metal housing
		4	EASG 10/250, Gr. 2	G	25–95	screened; <u>option</u> : with metal housing
		5	CE 24 – 250	W	95–120	screened
	Südkabel	6	SEHDG 11.1	G	25–120	screened; <u>option</u> : with metal housing
		7	SEW 12	W	25–120	screened; <u>option</u> : with metal housing
	Cooper Power Systems	8	DE 250 – R-C	W	16–120	screened
		9	DS 250 – R-C	G	16–120	screened
	Prysmian Kabel und Systeme (Pirelli Elektrik)	10	FMCE-250	W	25–120	screened
	3M	11	93-EE 605-2/-95	W	25–95	screened; <u>option</u> : with metal housing
		12	93-EE 600-2/xx	G	25–150	screened; <u>option</u> : with metal housing
	TE Connectivity	13	RSSS 52xx	G	25–95	screened; with capacitive measuring point
		14	RSES 52xx-R	W	25–120	screened; with capacitive measuring point

Thermoplastic-insulated cables 15/17.5/24 kV according to IEC/EN 60502-2/VDE 0276-620

1-core cable, PE and XLPE-insulated N2YSY (Cu) and N2XSY (Cu) or NA2YSY (Al) and NA2XSY (Al)	Nexans	15	K158 LR	W	16–120	screened; with capacitive measuring point
		16	K152 SR	G	25–120	screened; with capacitive measuring point
	nkt cables	17	EASG 20/250	G	25–95	screened; <u>option</u> : with metal housing
		18	CE 24 – 250	W	25–95	screened
	Südkabel	19	SEHDG 21.1	G	25–70	screened; <u>option</u> : with metal housing
		20	SEW 24	W	25–95	screened; <u>option</u> : with metal housing
	Cooper Power Systems	21	DE 250 – R-C	W	16–120	screened
		22	DS 250 – R-C	G	16–120	screened
	Prysmian Kabel und Systeme (Pirelli Elektrik)	23	FMCE-250	W	25–120	screened
	3M	24	93-EE 605-2/-95	W	25–95	screened; <u>option</u> : with metal housing
		25	93-EE 600-2/xx	G	25–150	screened; <u>option</u> : with metal housing
	TE Connectivity	26	RSSS 52xx	G	16–70	screened; with capacitive measuring point
		27	RSES 52xx-R	W	16–120	screened; with capacitive measuring point

1) G = Straight cable plug
W = Cable elbow plug

Components

Cable connections

Cable testing

- For circuit-breaker and switch-disconnector feeders
- Cable testing equipment can be connected after removing the protective cap and/or the end stopper from the cable plug
- Cable testing equipment and cable T-plug each of the same make
- DC voltage test

Before the test:

Remove any voltage transformers available at the cable connection; short-circuit voltage indicators with earthing points of test sockets.

8DJH switchgear for rated voltages up to 24 kV can be subjected to cable tests at a DC test voltage of max. 96 kV (when the switchgear is new) or, according to VDE, at 70 kV for 15 minutes. The voltage at the busbar may be 24 kV in this case.

- Test voltages:

Rated voltage		Max. test voltage applied to the connected cable (according to IEC/EN VDE 0278)		
		VLF ¹⁾ 0.1 Hz		
U_r (kV)	$U_0/U(U_m)$ (kV)	$3 \cdot U_0$ U_{LF} AC (kV)	U_m DC (kV)	$6 \cdot U_0, 15 \text{ min}$ max. U_m DC (kV)
12	6/10(12)	19	24	38 ²⁾
24	12/20(24)	38	48	70

- For cable testing, the following must be observed:
 - Installation and operating instructions of the switchgear
 - Standards IEC/EN 62271-200/VDE 0671-200 *)
 - Data of the manufacturer-specific cable sealing end
 - Cable design (paper-insulated mass-impregnated cable, PVC or XLPE cable).

1) VLF = very low frequency

2) Referred to $U_0/U(U_m) = 6.35/11$ (12 kV)

*) For standards, see page 89

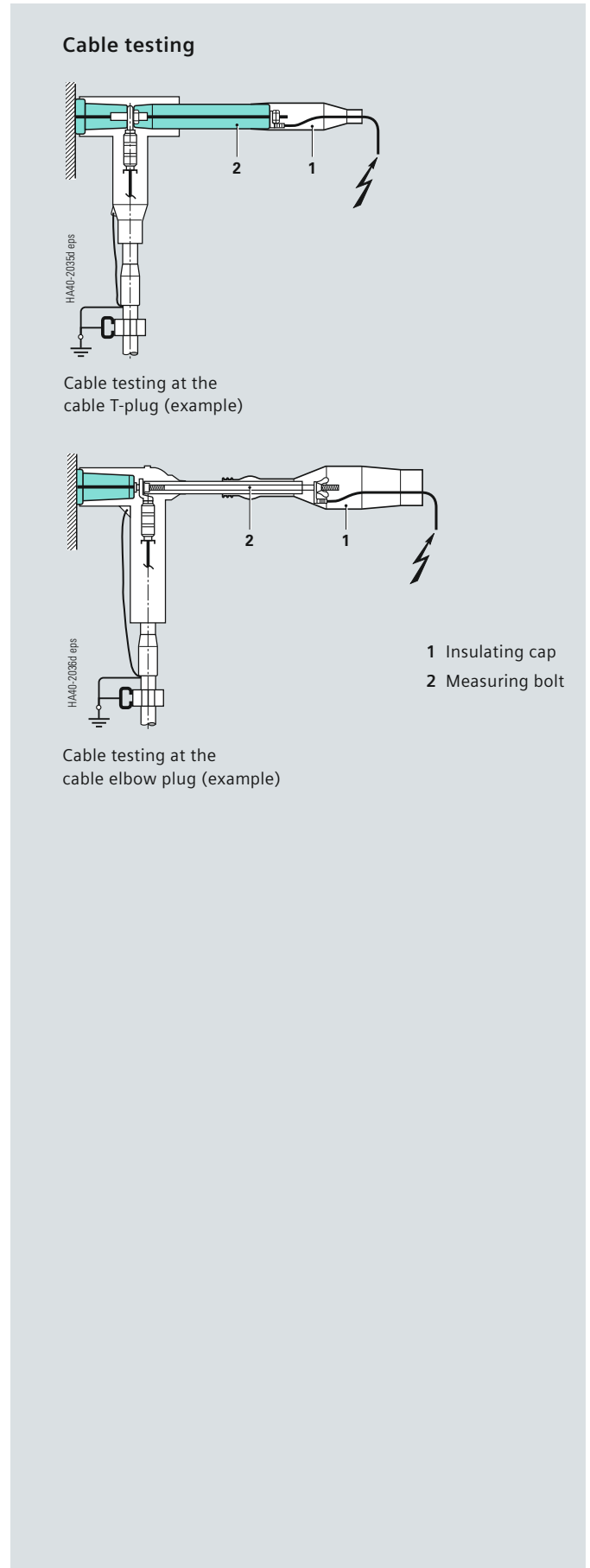

Standard interlocks

- Three-position switch: Disconnecting function against earthing function
- Circuit-breaker feeder: Circuit-breaker against three-position disconnector
- Access to cable compartment is generally only possible if
 - the feeder is isolated
 - and
 - the feeder is earthed ("EARTHED" position).

For ring-main and circuit-breaker feeders

- Option: Closing lockout
Prevents switching the three-position switch-disconnector from "OPEN" position to "CLOSED" position when the cable compartment cover is removed.

For transformer feeders

- The three-position switch-disconnector cannot be switched from "EARTHED" to "OPEN" position when the cable compartment cover/the HV HRC fuse compartment is open.

Locking device for padlock

- Shackle diameter 12 mm
- Standard for transformer and circuit-breaker feeders (stored-energy mechanisms)
- Option for ring-main feeders (spring-operated mechanisms)
- Three-position switch-disconnector lockable at the operating mechanism in any desired switch position.

Key-operated interlock (option)

- With cylinder locks from selected manufacturers
- For the basic functionalities:
 - Switch-disconnector/disconnector
 - KF 1 Key free in OPEN
 - Key trapped in CLOSED
 - Earthing switch
 - KF 2 Key free in OPEN
 - Key trapped in EARTHED
 - KF 3 Key free in EARTHED
 - Key trapped in OPEN

These basic functionalities can be combined at will. Furthermore, it is possible to integrate cylinder locks, e.g. of doors to transformer rooms, or external key boxes.

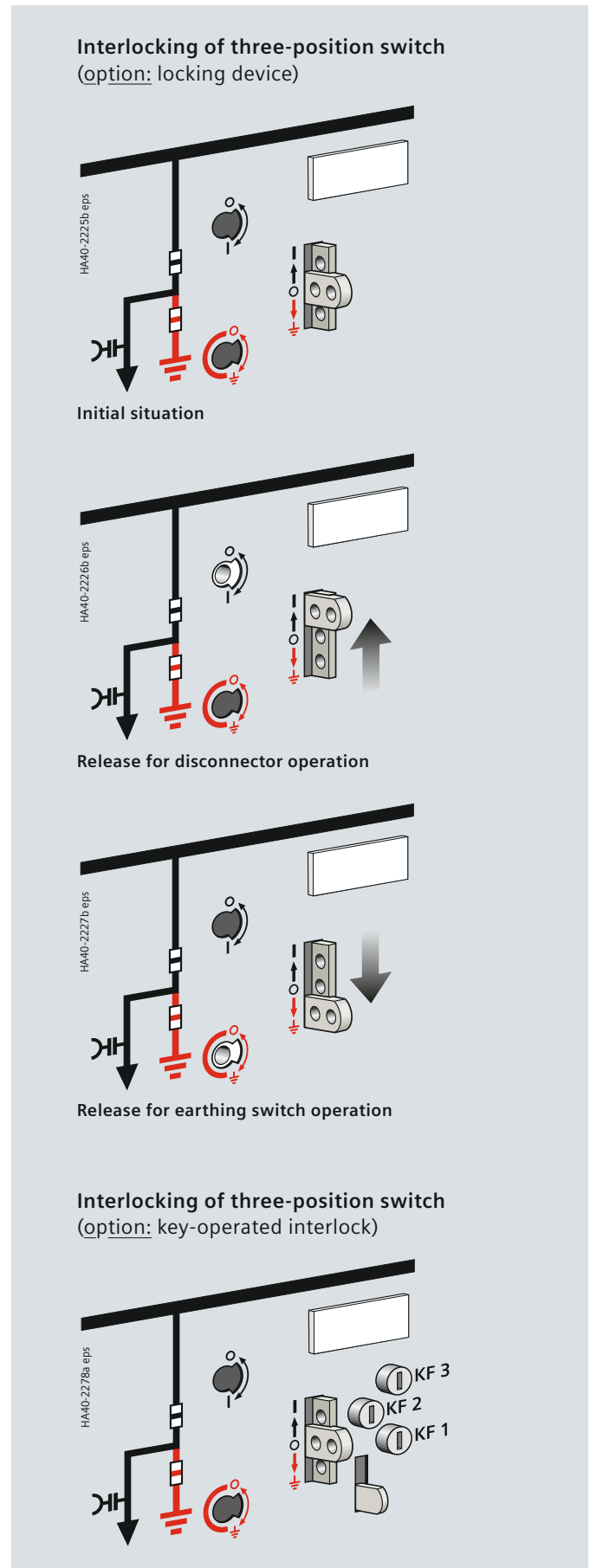

Components

Indicating and measuring equipment

Ready-for-service indicator

Features

- Self-monitoring; easy to read
- Independent of temperature and pressure variations
- Independent of the site altitude
- Only responds to changes in gas density
- Option: Alarm switch "1NO + 1NC" for remote electrical indication.

Mode of operation

For the ready-for-service indicator, a gas-tight measurement box is installed inside the switchgear vessel.

A coupling magnet, which is fitted to the bottom end of the measurement box, transmits its position to an outside armature through the non-magnetizable switchgear vessel. This armature moves the ready-for-service indicator of the switchgear.

While changes in the gas density during the loss of gas, which are decisive for the dielectric strength, are displayed, temperature-dependent changes in the gas pressure are not. The gas in the measurement box has the same temperature as that in the switchgear vessel.

The temperature effect is compensated via the same pressure change in both gas volumes.

Gas monitoring

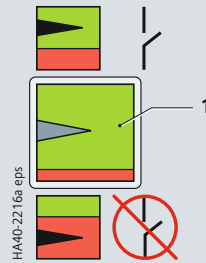

- Indicator on control board:
- 1 Indication:
 - green: ready for service
 - red: not ready for service
 - 2 Measurement box
 - 3 Magnetic coupling

Principle of operation

of gas monitoring with ready-for-service indicator

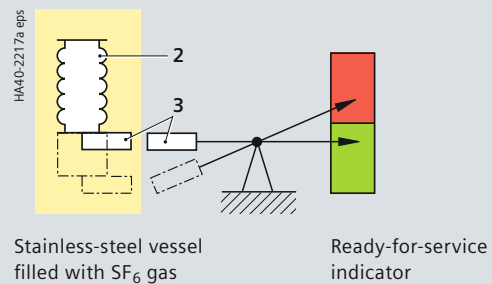

Voltage detecting systems according to IEC 61243-5 or VDE 0682-415, IEC 62271-206 or VDE 0671-206 (WEGA ZERO)

- To verify safe isolation from supply
- LRM detecting systems
 - with plug-in indicator
 - with integrated indicator, type VOIS+, VOIS R+, WEGA ZERO
- with integrated indicator, with integrated repeat test of the interface, with integrated function test, type CAPDIS-S1+, WEGA 1.2, WEGA 1.2 Vario, with integrated signaling relay, type CAPDIS-S2+, WEGA 2.2.

Plug-in voltage indicator

- Verification of safe isolation from supply phase by phase
- Indicator suitable for continuous operation
- Measuring system and voltage indicator can be tested
- Voltage indicator flashes if high voltage is present.

VOIS+, VOIS R+

- Integrated display, without auxiliary power
- With indication "A1" to "A3" (see legend)
- Maintenance-free, repeat test required
- With integrated 3-phase LRM test socket for phase comparison
- With integrated signaling relay (only VOIS R+)
- Degree of protection IP54.

Common features CAPDIS-Sx+

- Maintenance-free
- Integrated display, without auxiliary power
- Integrated repeat test of the interfaces (self-monitoring)
- With integrated function test (without auxiliary power) by pressing the "Display-Test" pushbutton
- Adjustable for different operating voltages (adjustable capacitance C2)
- With integrated 3-phase LRM test socket for phase comparison
- With connectable signal-lead test
- With overvoltage monitoring and signaling (1.2 times operating voltage)
- Degree of protection IP54.

CAPDIS-S1+

- Without auxiliary power
- With indication "A1" to "A7" (see legend)
- Without ready-for-service monitoring
- Without signaling relays (without auxiliary contacts).

CAPDIS-S2+

- With indication "A0" to "A8" (see legend)
- Only by pressing the "Test" pushbutton: "ERROR" indication (A8), e.g. in case of missing auxiliary voltage
- With ready-for-service monitoring (auxiliary power required)
- With integrated signaling relay for signals (auxiliary power required).

Indicators and detecting systems

R-HA40-103 eps



Plug-in voltage indicator
per phase at the panel front

R-HA40-104 eps



Integrated voltage indicator
VOIS+, VOIS R+

R-HA35-154 eps



R-HA35-155 eps



Integrated voltage detecting system
CAPDIS-S1+, -S2+

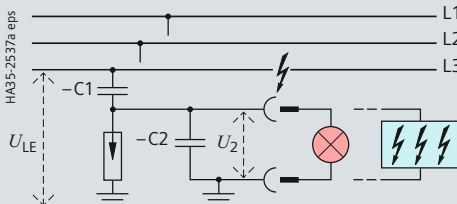

LRM system CAPDIS/VOIS
plugged in installed

Voltage indication

via capacitive voltage divider (principle)

- C1 Capacitance integrated into bushing
- C2 Capacitance of the connection leads and the voltage indicator to earth

$$U_{LE} = U_N / \sqrt{3} \text{ during rated operation in the three-phase system}$$

$$U_2 = U_A = \text{Voltage at the capacitive interface of the switchgear or at the voltage indicator}$$

Symbols shown

	VOIS+, VOIS R+ CAPDIS-S1+			CAPDIS-S2+		
	L1	L2	L3	L1	L2	L3
A0						000
A1	⚡	⚡	⚡	⚡	⚡	⚡
A2						
A3	⚡	⚡		⚡	⚡	⚡
A4				⚡	⚡	⚡
A5				000	000	000
A6				000	000	000
A7				000	000	000
A8						000

HA35-2579b eps

A0 CAPDIS-S2+: Operating voltage not present

A1 Operating voltage present

A2 – Operating voltage not present
– For CAPDIS-S2+: Auxiliary power not present

A3 Failure in phase L1, operating voltage at L2 and L3 (for CAPDIS-Sx+ also earth-fault indication)

A4 Voltage (not operating voltage) present

A5 Indication "Test" passed (lights up briefly)

A6 Indication "Test" not passed (lights up briefly)

A7 Overvoltage present (lights up permanently)

A8 Indication "ERROR", e.g.: in case of missing auxiliary voltage

Components

Indicating and measuring equipment

WEGA ZERO

- Voltage detecting system according to IEC 62271-206 or VDE 0671-206
- With indication "A1" to "A4" (see legend)
- Maintenance-free
- With integrated 3-phase test socket for phase comparison
- Degree of protection IP54.



Integrated voltage indicator
WEGA ZERO



Integrated voltage detecting system
WEGA 1.2, WEGA 1.2 Vario



Integrated voltage detecting system
WEGA 2.2

WEGA 1.2, WEGA 1.2 Vario

- Voltage detecting system according to IEC 61243-5 or VDE 0682-415
- With indication "A1" to "A5" (see legend)
- Maintenance-free
- Integrated repeat test of the interface (self-monitoring)
- With integrated function test (without auxiliary power) by pressing the "Display Test" pushbutton
- With integrated 3-phase LRM test socket for phase comparison
- Without integrated signaling relay
- Without auxiliary power
- Degree of protection IP54
- Adjustable for different operating voltages (adjustable capacitance C2) (only for WEGA 1.2 Vario).

WEGA 2.2

- Voltage detecting system according to IEC 61243-5 or VDE 0682-415
- With indication "A0" to "A6" (see legend)
- Maintenance-free
- Integrated repeat test of the interface (self-monitoring)
- With integrated function test (without auxiliary power) by pressing the "Display Test" pushbutton
- With integrated 3-phase LRM test socket for phase comparison
- With integrated signaling relay (auxiliary power required)
- Degree of protection IP54.

Symbols shown

	WEGA ZERO			WEGA 1.2			WEGA 2.2		
	L1	L2	L3	L1	L2	L3	L1	L2	L3
A0							←	←	←
A1	☀	☀	☀	⚡	⚡	⚡	⚡	⚡	⚡
A2	○	○	○						
A3	○	☀	☀	⚡	⚡		←	⚡	⚡
A4	☀	☀	☀	⚡	⚡	⚡	⚡	⚡	⚡
A5				⚡	⚡	⚡	⚡	⚡	⚡
A6							⚡	⚡	⚡

LC display gray: not illuminated
LC display white: illuminated

- A0** For WEGA 2.2:
Operating voltage not present, auxiliary power present, LCD illuminated
- A1** Operating voltage present
For WEGA 2.2: Auxiliary power present, LCD illuminated
- A2** Operating voltage not present
For WEGA 2.2: Auxiliary power not present, LCD not illuminated
- A3** Failure in phase L1, operating voltage at L2 and L3
For WEGA 2.2: Auxiliary power present, LCD illuminated
- A4** Voltage present, current monitoring of coupling section below limit value
For WEGA 2.2: Auxiliary power present, LCD illuminated
- A5** Indication "Display-Test" passed
For WEGA 2.2: Auxiliary power present, LCD illuminated
- A6** For WEGA 2.2: LCD for missing auxiliary voltage is not illuminated

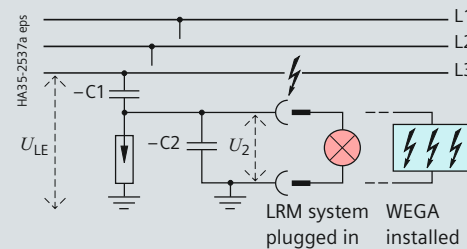

Voltage indication

via capacitive voltage divider (principle)

- C1 Capacitance integrated into bushing
- C2 Capacitance of the connection leads and the voltage indicator to earth

$$U_{LE} = U_N / \sqrt{3} \text{ during rated operation in the three-phase system}$$

$$U_2 = U_A = \text{Voltage at the capacitive interface of the switchgear or at the voltage indicator}$$

Verification of correct terminal-phase connections

- Verification of correct terminal-phase connections possible by means of a phase comparison test unit (can be ordered separately)
- Safe-to-touch handling of the phase comparison test unit by inserting it into the capacitive taps (socket pairs) of the switchgear.

Phase comparison test units according to IEC 61243-5 or VDE 0682-415

R-HA40-059.eps



Phase comparison test unit make Pfisterer, type EPV

as combined test unit (HR and LRM) for:

- Voltage detection
- Phase comparison
- Interface test
- Integrated self-test
- Indication via LED

R-HA40-089.tif



Phase comparison test unit make Horstmann, type ORION 3.1

as combined test unit (HR and LRM) for:

- Phase comparison
- Interface testing at the switchgear
- Voltage detection
- Integrated self-test
- Indication via LED and acoustic alarm
- Phase sequence indicator

R-HA35-124.eps



Phase comparison test unit make Kries, type CAP-Phase

as combined test unit (HR and LRM) for:

- Voltage detection
- Repeat test
- Phase comparison
- Phase sequence test
- Self-test

The unit does not require a battery

R-HA35-175.eps



Phase comparison test unit make Hachmann, type VisualPhase LCD

as combined test unit (HR and LRM) for:

- Voltage detection with measured-value indication
- Interface test
- Low voltage detection
- Documentable repeat test
- Phase comparison with LED signal and measured-value indication
- Phase angle from -180° to $+180^\circ$
- Phase sequence evaluation
- Frequency quality
- Complete self-test

Components

Indicating and measuring equipment

Short-circuit/earth-fault indicators make Horstmann

Short-circuit/earth-fault indicators (option)

Ring-main, cable, transformer and circuit-breaker feeders can optionally be equipped with short-circuit or earth-fault indicators in different designs. The equipment features are shown in the list enclosed.

Short-circuit and earth-fault indicators reduce the down-times of a power system by limitation of fault locations in medium-voltage systems.

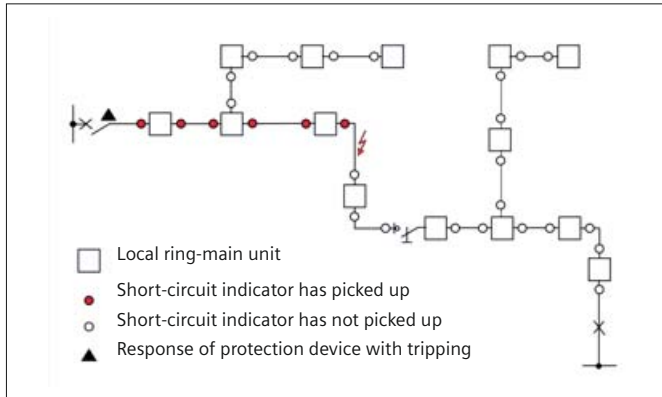

Short-circuit/earth-fault indicators can be used in radial systems and in openly operated ring systems. In impedance-earthed and solidly earthed systems, every short-circuit indicator can also be used as an earth-fault indicator.

Basic functions

- Adjustable pickup values
- Phase-selective fault indication
- Reset of fault indication: manually, automatically, from remote
- Remote indication with relay contacts.

Measuring function with ComPass A

- Measuring and indication of phase and earth currents
- Transfer of measured values, fault indications and events via RS485/Modbus.

ComPass B with further functions

- Short-circuit and earth-fault indication depending on direction
- Voltage detection via voltage detecting system type WEGA. This provides further measured values such as:
 - Phase and displacement voltage
 - Active, reactive and apparent power
 - Power factor \cos
 - Load flow direction
- Undervoltage and overvoltage signaling, indication
- Directional/non-directional fault detection for all types of neutral treatment.

SIGMA D, SIGMA D⁺ universal fault direction indicator

- Current-transformer operated short-circuit direction indicator and earth-fault direction indicator for all systems and neutral point connection types
- Unambiguous signaling of the fault direction
- Simple and flexible configuration via DIP switch and USB
- Event memory for fault evaluation.



Further types and information can be obtained directly from the manufacturer at www.horstmannmbh.com.

Short-circuit/ earth-fault indicators Horstmann	ALPHA M	ALPHA E	SIGMA	SIGMA F+E	SIGMA D	SIGMA D ⁺	ComPass A	ComPass AP	ComPass B	ComPass BP	EARTH/ EARTH ZERO
Function											
Short-circuit indication	x	x	x	x	x	x	x	x	x	x	
Earth-fault indication				x	x	x	x	x	x	x	x
Indication of direction, short circuit/earth fault					x	x			x	x	
Undervoltage and overvoltage indication									x	x	
Applicable for the following neutral earthing options											
Impedance	x	x	x	x	x	x	x	x	x	x	x
Solid	x	x	x	x	x	x	x	x	x	x	x
Isolated	x	x	x	x	x	x	x	x	x	x	
Compensated	x	x	x	x	x	x	x	x	x	x	
Short-circuit pickup values											
I>> Short-circuit current	400, 600, 800, 1000 A		200, 300, 400, 600, 800, 1000, (2000) ⁵⁾ A, self-adjustment		100, 200, 300, 400, 600, 800, 1000 A, self-adjustment ⁴⁾				50 ... 2000 A (steps of 1 A)		
tl>> Pickup delay	≤ 100 ms		40, 80 ms		40, 80 ms ⁴⁾ , 40 ms – 60 s				40 ms – 60 s		
Earth-fault pickup values											
IE> Earth-fault current				20, 40, 60, 80, 100, 120, 160 A	off, 20, 40, 60, 80, 100, 120, 160 A ⁴⁾				20...1000 A (steps of 1 A)		25, 50, 75, 100 A ⁷⁾
tlE> Pickup delay				80, 160 ms	80, 160 ms ⁴⁾ , 40 ms – 60 s				40 ms – 60 s		80, 160 ms ⁷⁾
IET> Transient earth fault						10 – 200 A					
IEP> Active residual current						5 – 200 A			5 – 200 A	5 – 200 A	
IEQ> Reactive current						5 – 200 A			5 – 200 A	5 – 200 A	
ΔIE> Pulse location (pulse amplitude)						1 – 100 A		1 – 100 A		1 – 100 A	
Feedback											
Manual	x	x	x	x	x	x	x	x	x	x	x
Automatic		x	x	x	x	x	x	x	x	x	x
From remote		x	x	x	x	x	x	x	x	x	x
Remote indication											
Passing contact	adjustable		adjustable		adjustable		adjustable		adjustable		adjustable
Maintained contact	adjustable		adjustable		adjustable		adjustable		adjustable		adjustable
Interface											
RS485/MODBUS							x	x	x	x	
USB 2.0					x	x					
Power supply											
Current-transformer operated	x	x	x ⁵⁾	x ⁵⁾	x	x					x
Long-duration lithium cell		x	x	x	x	x	x	x	x	x	x
Summation current			x ⁵⁾	x ⁵⁾		possible	x	x	x	x	x ⁵⁾
Current inputs											
Phase current	3	3	3	2 (3) ⁶⁾	3	3	3	3 (2) ¹⁾	3 (2) ¹⁾	3 (2) ¹⁾	
Summation current				1 (0) ⁶⁾	0 ¹⁾	1 ⁵⁾	0 ¹⁾	0 (1) ¹⁾	0 (1) ¹⁾	0 (1) ¹⁾	1
Voltage inputs											
Via WEGA 1.2C/WEGA 2.2C					3	3			3	3	
Resistive voltage coupling									x		
Measuring function											
Current							x ²⁾	x ²⁾	x ²⁾	x ²⁾	
Voltage									x	x	
Load flow direction									x	x	
cos phi									x	x	
Frequency							x	x	x	x	
Relay outputs											
Potential-free	1	1	1	3	4 ³⁾	4 ³⁾	4 ³⁾	4 ³⁾	4 ³⁾	4 ³⁾	1
Binary inputs											
Number		1	2 (test + reset)		2 (test + reset)		1 ³⁾	1 ³⁾	1 ³⁾	1 ³⁾	1

1) Measuring sensor 3+0 (summation current is calculated),
measuring sensor 2+1 (phase L2 is calculated)

2) Momentary values: Ø 15 min, max 24 h, max. 7 d, max. 365 d, slave-pointer function

3) Freely programmable

4) Alternatively adjustable via DIP switch

5) Optional

6) No calculation of the missing phase or summation current

7) Further settings optionally possible

Components

Indicating and measuring equipment

Short-circuit / short-circuit-to-earth and earth-fault indicators, make Kries

Ring-main, cable, transformer and circuit-breaker feeders can optionally be equipped with short-circuit or earth-fault indicators in different designs. The equipment features are shown in the opposite table.

The three most common types of faults in medium-voltage systems are earth faults in cables and switchgear, faults and overloads of distribution transformers, as well as short circuits in cables and switchgear. For fast fault location and minimization of downtimes, electronic fault indicators are used:

- Selective fault detection, and thus minimization of downtimes
- Reliable fault detection through electronic measured-value acquisition
- Remote indication of fault events and measured values.

1. Short-circuit and earth-fault indicator IKI-20

- Universally adjustable
- Current-transformer supported battery version or auxiliary voltage versions available
- Extended commissioning and testing functions.

2. Short-circuit and earth-fault indicator IKI-20PULS

- Short-circuit detection same as IKI-20
- Earth-fault detection via pulse location in compensated systems.

3. Short-circuit and earth-fault indicator IKI-20C(PULS)

- Current-transformer operated (no battery no auxiliary voltage)
- Optionally with pulse location for earth-fault detection in compensated systems.

4. Directional short-circuit and earth-fault indicator IKI-22

- Directional fault detection for all system types
- Directional detection combined with the voltage detecting system CAPDIS.

5. Substation control unit IKI-50

- Directional measured-value acquisition
- Directional fault detection for all system types
- Switchgear control or automation
- One device controls two cable panels plus load flow total
- Directional detection combined with the voltage detecting system CAPDIS.

6. Short-circuit-to-earth indicator

- Short-circuit-to-earth detection in systems with impedance-earthed neutral or temporarily impedance earthed-neutral
- Adjustable.



IKI-20



IKI-20CPULS



IKI-22



IKI-50



IKI-10light

Further types and information can be obtained directly from the manufacturer at www.kries.com.

Short-circuit/ earth-fault indicators Kries	IKI- 20B	IKI- 20T	IKI- 20U	IKI-20PULS	IKI-20C	IKI- 20CPULS	IKI-22	IKI- 50_1F	IKI- 50_1F_ EW_PULS	IKI- 50_2F	IKI- 50_2F_ EW_PULS	IKI- 10-light-P
Function												
Short-circuit indication	x	x	x	x	x	x	x	x	x	x	x	
Earth-fault indication				x		x	x	x	x	x	x	
Short-circuit-to-earth indication ⁵⁾	x	x	x		x		x	x	x	x	x	x
Direction indication							x	x	x	x	x	
Applicable for the following neutral earthing options												
Impedance	x	x	x		x		x	x	x	x	x	x
Solid	x	x	x		x		x	x	x	x	x	x
Isolated	x	x	x		x	x	x	x	x	x	x	
Compensated	x	x	x	x	x		x	x	x	x	x	
Pickup current												
Short-circuit current	100, 200, 400, 600, 800, 1000, 2000 A				400, 600, 800, 1000 A		100, 200, 300, 400, 600, 800, 1000, 2000 A		100 ... 1000 A (steps of 100 A)			
Earth-fault current							Transient fault detection		4 ... 30 A (steps of 1 A)			
Short-circuit-to-earth current ⁵⁾	40, 80, 100, 150 A						40, 80, 100, 200 A		40 ... 200 A (steps of 10 A)			20, 40, 60, 80 A
Pulse location					x		x			x		x
Pickup time												
Short-circuit current	60, 80, 150, 200 ms				100 ms		60, 80, 150, 200 ms		60 – 1600 ms			
Short-circuit-to-earth current ⁵⁾	60, 80, 150, 200 ms				100 ms		60, 80, 150, 200 ms		60 – 1600 ms			70, 250 ms
Earth-fault current					Pulse location		Pulse location	Transient fault detection		400 – 3000 ms		
Reset												
Manual	x	x	x	x	x	x	x	x	x	x	x	x
Automatic	x	x	x	x	x	x	x	x	x	x	x	x
From remote	x	x	x	x			x	x	x	x	x	x
Remote indication												
Passing contact	adjustable				x	x	x	adjustable				
Maintained contact	adjustable							adjustable				
Interface												
RS485/MODBUS								x	x	x	x	
Power supply												
Lithium battery	x						x					x
External auxiliary voltage		x	x	x			Only for transient fault detection	Buffered for 6 h by internal capacitor				x
Current inputs												
Phase current	3	3	3	3	3	3	3	3	3	6	6	
Summation current	1	1	1	1		1		1 ¹⁾	0 ²⁾	0 ²⁾	0 ²⁾	1
Voltage inputs												
Via CAPDIS + Y-cable								3	3	6	6	
Measuring function												
Current								x ⁴⁾	x ⁴⁾	x ⁴⁾	x ⁴⁾	
Voltage								x ⁴⁾	x ⁴⁾	x ⁴⁾	x ⁴⁾	
Load flow direction								x ⁴⁾	x ⁴⁾	x ⁴⁾	x ⁴⁾	
cos phi								x ⁴⁾	x ⁴⁾	x ⁴⁾	x ⁴⁾	
Frequency								x ⁴⁾	x ⁴⁾	x ⁴⁾	x ⁴⁾	
Active power								x ⁴⁾	x ⁴⁾	x ⁴⁾	x ⁴⁾	
Apparent power								x ⁴⁾	x ⁴⁾	x ⁴⁾	x ⁴⁾	
Reactive power								x ⁴⁾	x ⁴⁾	x ⁴⁾	x ⁴⁾	
Release outputs												
Potential-free	1 – 3	1 – 3	1 – 3	1 – 3	2	2	4	4	4	4	4	1
Supplied by internal capacitor								2 ³⁾	2 ³⁾	2 ³⁾	2 ³⁾	
Binary inputs												
Number	2 (test + reset)						2 (test + reset)					4

1) Optional for wattmetric detection of earth-fault direction

2) Creation of sum signal via 3 transformers mounted around the conductor

3) 0.1 Ws, 24 V DC

4) Momentary value, mean value and min/max value, directional

5) Short-circuit to earth = Earth fault in impedance-earthed system

Components

Indicating and measuring equipment

Short-circuit/earth-fault indicator Siemens	SICAM FCM
Function	
Short-circuit indication	x
Earth-fault indication	x
Earth-fault function (impedance-earthed system)	x
Indication of direction, short-circuit/earth-fault	x
Undervoltage and overvoltage indication	x
Applicable for the following neutral earthing options	
Impedance	x
Solid	x
Isolated	x
Compensated	x
Pickup current	
Short-circuit current	50 ... 2000 A (steps of 1 A)
Earth-fault current	1 ... 1000 A (steps of 1 A)
Pulse location	–
Pickup time	
Short-circuit current	40 ms < t < 60 s
Earth-fault current	40 ms < t < 60 s
Reset	
Manual	x
Automatic	x
From remote	x
Remote indication	
Passing contact	adjustable
Maintained contact	adjustable
Interface	
RS485/MODBUS	x
Power supply	
Lithium battery	x
External auxiliary voltage	x
Current inputs	
Phase current	3 (2) ¹⁾
Summation current	0 (1) ¹⁾
Voltage inputs	
Via WEGA 1.2C / WEGA 2.2C	3 x
Measuring function	
Current	x
Voltage	x
Load flow direction	x
cos phi	x
Frequency	x
Active power	x
Apparent power	x
Reactive power	x
Relay outputs	
Potential-free	2 ²⁾
Binary inputs	
Number	1



Short-circuit and earth-fault indicators, make Siemens

SICAM FCM is a short-circuit and earth-fault indicator with direction indication, operating with protection algorithms and advanced low-power current and voltage sensors according to IEC 60044.

Main features:

- Usable in earthed, isolated and resonance-earthed systems
- Directional short-circuit and earth-fault detection
- Precise and fast fault localization reduces expenses for personnel and traveling costs
- Selective fault information with direction indication as a basis for "self-healing" applications
- Resupply times possible in the range of minutes or seconds (depending on the primary part of the switchgear)
- Minimum loss of power grid and end consumer revenues
- Reliable measured values for operational management and planning
- Targeted application of investment funds during network planning and grid expansion
- Use of low-power sensors and high-quality measuring systems with a measuring accuracy of 99%.

SICAM FCM operates with sensors conforming to the standard IEC 60044-7/8. This enables exact measurements without calibration or adjustment to the primary magnitudes.

1) Measuring sensor 3+0 (summation current is calculated), measuring sensor 2+1 (phase L2 is calculated)

2) Optional

Transformer monitor IKI-30 (make Kries)

Application with vacuum circuit-breaker

Protection of distribution transformers with ratings that cannot or should not be protected with HV HRC fuses:

- Tripping of the circuit-breaker in case of overload (delayed)
- Tripping of the circuit-breaker when the short-circuit current arises.



Transformer monitor IKI-30

Application

The transformer monitor IKI-30 is suitable for the following transformer ratings:

- Operating voltage 6 to 15 kV: ≥ 160 kVA
- Operating voltage 20 kV: ≥ 250 kVA.

Features

- Current-transformer operated, alternatively auxiliary voltage 24 to 230 V AC/DC
- Instrument transformers
 - Special cable-type current transformers
 - No direction-dependent installation required
 - No earthing of an instrument transformer pole required
 - No short-circuit terminals required for maintenance

- Low-energy magnetic release (0.02 Ws)
- Optional shunt release for auxiliary voltage supply
- Mounting location
 - In the front operating mechanism box of the feeder panel
 - In the low-voltage compartment (option) of the circuit-breaker feeder
- Response performance
 - Definite-time overcurrent characteristic
 - Definite-time overcurrent characteristic for earth-fault protection
 - Inverse-time overcurrent characteristic
 - extremely inverse
 - normal inverse
 - Externally undelayed instantaneous tripping
- Self-test function
 - Display test LED (red)
 - Battery test (under load), LED (green)
 - Primary current test with tripping and with primary current injection into the instrument transformers
- Indication
 - LED indication for tripping (single flash: starting; double flash: tripping)
 - Reset after 2 h or automatically (after return of power) or manually with reset pushbutton
- Outputs
 - Tripping signal: 1 floating relay output (NC contact) for telecommunication as passing contact
 - Starting signal: 1 floating relay output (NC contact) – is activated as long as the starting criterion is reached, e.g. to block an upstream primary protection
 - 1 watchdog (relay)
 - 1 external tripping output for control of an existing release, e.g. via capacitor
 - Tripping output designed as impulse output for direct control of the low-energy release
- Input
 - Remote tripping signal, control via floating external contact
 - Instantaneous tripping.

Components

Intelligent transformer substation

Equipment examples for the switchgear





8DJH switchgear can be equipped with motor operating mechanisms, voltage detecting and measuring devices, short-circuit indicators, and further detection systems. RTUs (Remote Terminal Units) can be optionally integrated inside the switchgear, in additional low-voltage compartments, or in a separate wall cubicle via a plug connection.

In this way, the switchgear fulfills all preconditions for integration in an intelligent network infrastructure. Depending on the purpose, different components for monitoring and control are used: These components can also be easily and quickly retrofitted at a later time. An equipment example for the switchgear is illustrated here.

The integration

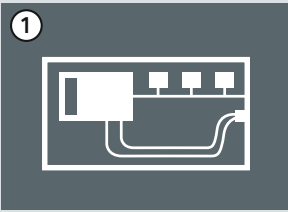
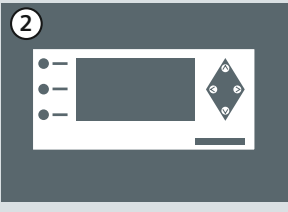
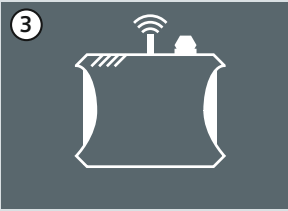

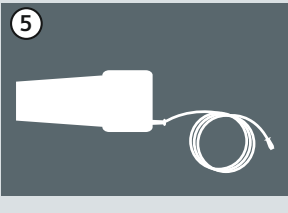
- 1 Uninterruptible power supply (UPS)
- 2 Intelligent SC indicators
- 3 Remotely controllable operating mechanisms
- 4 Current sensors
- 5 Voltage sensors
- 6 Communication modem
- 7 Remote terminal unit

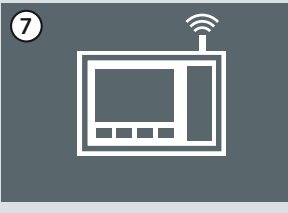
	Components	Function
	<p>Uninterruptible power supply (UPS) Depending on the requested bridging time in case of power failures, an uninterruptible power supply based on battery or capacitor modules is used.</p>	<p>The task of the UPS is to continue to ensure the communication and/or the possibility to telecontrol the transformer substation in case of power failure.</p>
	<p>Intelligent SC indicators Intelligent short-circuit and ground fault indicators with or without direction indication can be used in all grid types. For communication with the RTU, a Modbus RTU interface is available.</p>	<p>Intelligent short-circuit/ground fault direction indicators report short-circuits or ground faults in the medium-voltage distribution grid. Relevant measured values are acquired, allowing for an active load management in the distribution grid.</p>
	<p>Remotely controllable operating mechanisms Motor operating mechanisms inside the ring-main unit are available in original equipment manufacturer quality. If required, retrofitting is easily possible.</p>	<p>In order to reduce the reclosing times in case of fault, the switch-disconnectors or circuit-breakers are equipped with motor operating mechanisms for remote control.</p>
	<p>Current sensors Current sensors with low-power transformer technology are available as closed or divisible ring cores.</p>	<p>The current signal serves to detect short-circuits and ground faults, and can be used as a measured value for load flow control or for optimal utilization of the grid capacity.</p>
	<p>Voltage sensors Voltage sensors as resistor dividers are available as cast-resin plugs for insertion into the cable T-plug.</p>	<p>The voltage signal serves to detect the direction of the short-circuit or ground fault, and can be used as a measured value for load flow control or voltage regulation.</p>
	<p>Communication modem The selection of the communication modem to be used is determined by the selected or available telecommunication technology.</p>	<p>Communication modems are employed for safe data transmission from the remote terminal unit to the network control center using the selected telecommunication technology.</p>
	<p>Remote terminal unit The remote terminal unit (RTU) is equipped with binary inputs and outputs, various communication interfaces, and freely programmable user programs.</p>	<p>Inside the intelligent transformer substation, the RTU serves as a connecting element to the network control center. It collects all relevant signals and receives control commands, or works autonomously according to pre-determined control or regulation algorithms.</p>

Components

Protection systems

Simple protection systems

As a simple protection for distribution transformers and circuit-breaker feeders, standard protection systems are available, consisting of:

- Current-transformer operated protection device with c.t.-operated release (low-energy 0.1 Ws)
 - Siemens 7SJ45
 - Woodward/SEG WIC 1-2P, WIC 1-3P, WIP-1
- Protection device with auxiliary voltage supply with shunt release (f)
 - Siemens 7SJ46
- Instrument transformer as
 - Cable-type current transformer (standard)
 - Three-phase current transformer as option for 8DJH switchgear panels L(500).

Mounting location

- In 200-mm-high top low-voltage unit (option) of the circuit-breaker feeder.

Application of simple protection systems

Operating voltage (kV)	Transformer rating (kVA)	
	7SJ45/7SJ46	WIC 1-2P
6	≥ 160	≥ 160
10	≥ 200	≥ 250
13.8	≥ 250	≥ 400
15	≥ 315	≥ 400
20	≥ 400	≥ 500

Multifunction protection (selection)

SIPROTEC Compact series, overcurrent protection SIPROTEC 7SJ80

- 9 programmable function keys
- 6-line display
- USB front port
- 2 additional communication ports
- IEC 61850 with integrated redundancy (electrical or optical)
- Relay-to-relay communication through Ethernet (IEC 61850 GOOSE).

SIPROTEC 4 series, overcurrent and motor protection SIPROTEC 7SJ61/ 7SJ62

- For stand-alone or master operation
- Communications and bus capability
- Functions: Protection, control, signaling, communication and measuring
 - LC text display (4 lines) for process and equipment data, as text, e.g. for
 - Measuring and metering values
 - Information on status of switchgear and switching device
 - Protection data
 - General indications
 - Alarms
- Four freely programmable function keys
- Seven freely programmable LEDs for displaying any desired data
- Keys for navigation in menus and for entering values
- Fault recorder.



SIPROTEC 5 series, overcurrent protection SIPROTEC 7SJ82

- Directional and non-directional time-overcurrent protection with additional functions
- Time optimization of the tripping times by directional comparison and protection data communication
- Frequency protection and rate-of-frequency-change protection for load shedding applications
- Overvoltage and undervoltage protection in all required variations
- Power protection, configurable as active or reactive power protection
- Control, synchrocheck and switchgear interlocking system
- Firmly integrated, electrical Ethernet port J for DIGSI
- Complete IEC 61850 (Reporting and GOOSE) via integrated port J
- Two optional, pluggable communication modules usable for different and redundant protocols (IEC 61850, IEC 60870-5-103, DNP3 (serial+TCP), Modbus RTU Slave, protection data communication).

Other types and makes on request

Mounting location

- In the 400 mm, 600 mm, or 900 mm high low-voltage compartment (option) of the circuit-breaker feeder.

Features

- Overall heights
 - 200 mm, 400 mm, 600 mm, 900 mm
 - Option: Cover
- Partitioned safe-to-touch from the high-voltage part of the panel
- Installation on the panel:
 - Possible per feeder
 - Standard for circuit-breaker panels type L (1.1) and bus sectionalizer panels
 - Option for all other panel types, depending on the scope of the secondary equipment
- Customer-specific equipment
 - For accommodation of protection, control, measuring and metering equipment
- Separate wiring duct on the switchgear beside the low-voltage compartment (option)
- Door with hinge on the left (standard for heights of 400, 600 and 900 mm).

Low-voltage cables

- Control cables of the panel to the low-voltage compartment via multi-pole, coded module plug connectors
- Option: Plug-in bus wires from panel to panel in the separate wiring duct on the panel.

Low-voltage niche

- Only inside billing metering panels type M
- For accommodation of options, e.g.:
 - Voltage transformer m.c.b.s
 - Small distribution fuse-box and fuse-links type Diazed or Neozed.

Low-voltage compartment (example 500 x 600 mm)



Open low-voltage compartment with built-in equipment (option)

Low-voltage niche

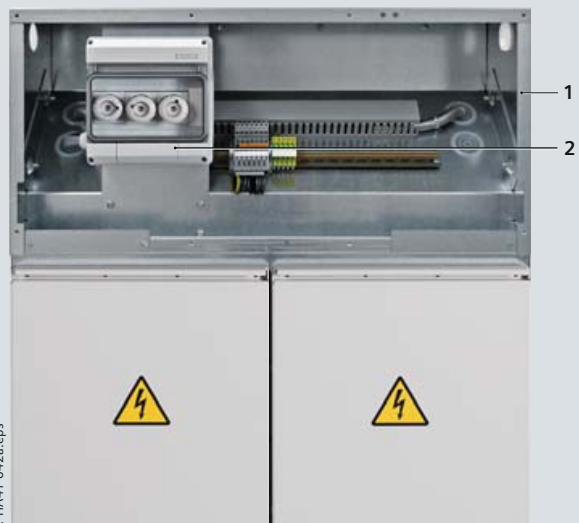

Low-voltage niche of a billing metering panel type M with open cover

- 1 Low-voltage niche
- 2 Built-in equipment (option)

Dimensions

Room planning

Please observe the following for room planning and switchgear installation:

Switchgear installation

Wall-standing arrangement

- 1 row
- 2 rows (for face-to-face arrangement)

Option: Free-standing arrangement.

Pressure relief

The type of pressure relief selected has an effect on the switchgear depth, and places requirements on the size of the cable basement and/or the room height. In case of pressure relief upwards, the room heights reproduced in the type test are decisive for the internal arc classification acc. to IEC/EN 62271-200/VDE 0671-200 (see table on page 67).

Door dimensions

The door dimensions have an influence on the size of the transport units (see page 87) and the factory assembly of panel groups, low-voltage compartments and pressure absorber systems. If required, this installation work can also be performed on site by the customer.

Switchgear fixing

- For floor openings and fixing points of the switchgear, see pages 83 to 86
- Foundations:
 - Steel girder construction
 - Reinforced-concrete floor.

Panel dimensions

See illustrations on pages 69 to 86.

Weight

For data, see page 88.

Local regulations and guidelines

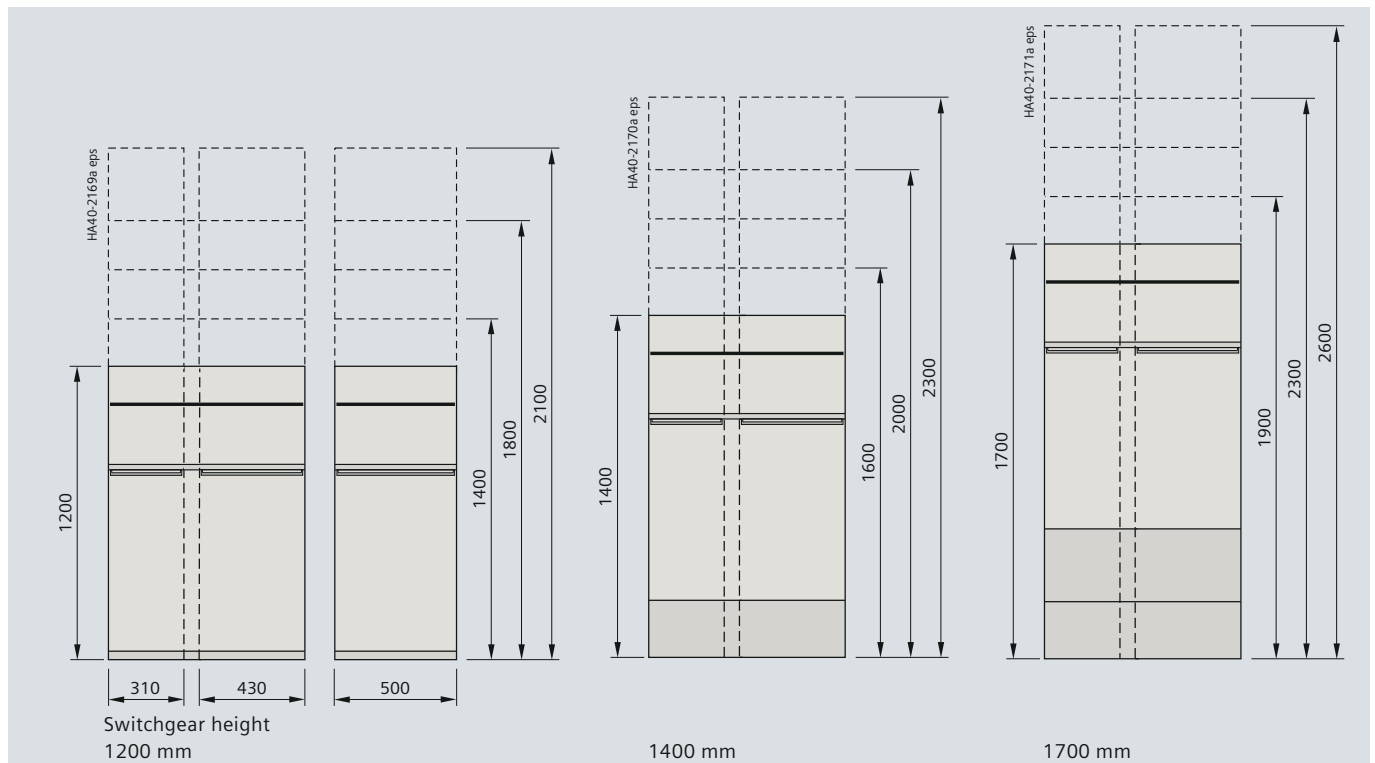
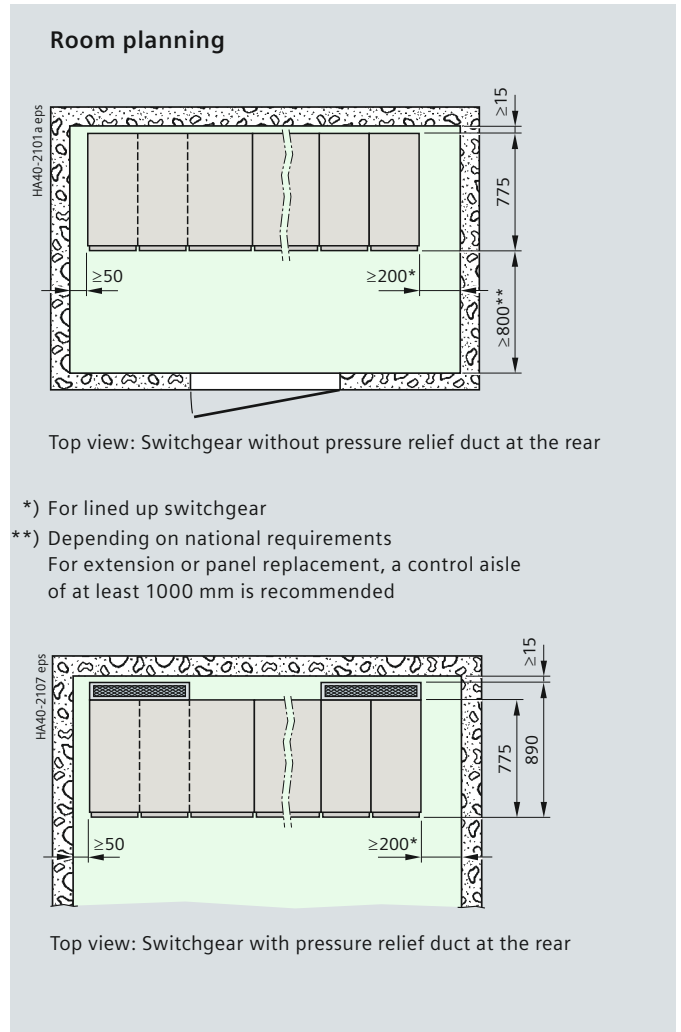

The following type-tested versions of the pressure relief system are available for 8DJH switchgear:

- Downwards into the cable basement (for individual panels and panel blocks, internal arc classification up to IAC A FL 21 kA /1 s or IAC A FLR 21 kA /1 s, minimum cross-section of the cable basement according to the illustration below)
- To the rear (for non-extendable panel blocks with 1400 or 1700 mm switchgear height, internal arc classification up to IAC A FL 21 kA/1 s, a rear pressure relief outlet with a minimum cross-section of 1 m² is required in the switchgear room and must be supplied by the site)
- Upwards through rear pressure relief duct (for extendable and non-extendable panel blocks, internal arc classification up to IAC A FL 16 kA /1 s, minimum room heights according to the table below), with pressure absorber system
- Upwards through base and rear pressure relief duct (for individual panels and panel blocks, internal arc classification up to IAC A FL 21 kA/1 s and IAC A FLR 21 kA/1 s, minimum room heights according to the table below), with pressure absorber system.

Switchgear installation with pressure relief downwards (standard) or to the rear (option)

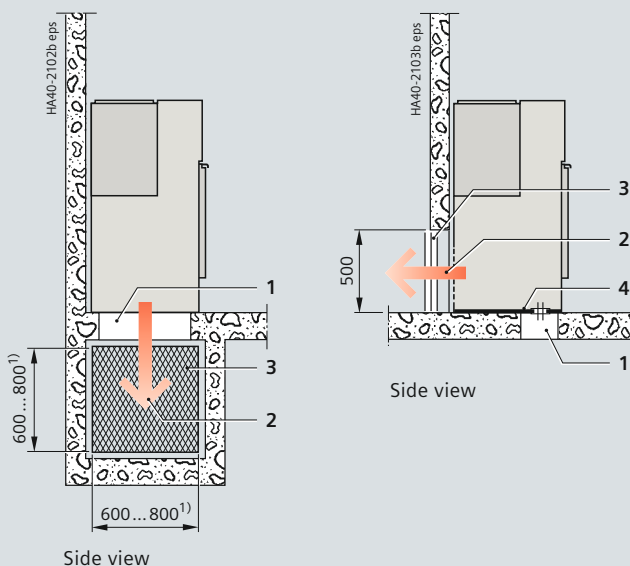

- 1 Floor opening
 - 2 Direction of pressure relief
 - 3 Expanded metal (supplied by site)
 - 4 Pressure-resistant floor cover (divided plate for comfortable working at the cable connection)
 - 5 Pressure absorber system with pressure relief duct
- 1) Total opening minimum 0.48 m²

Room heights for switchgear installation with pressure relief duct at the rear (design with or without base)

Switchgear height	Room height
1400 mm	≥ 2000 mm
1700, 1800 mm	≥ 2200 mm
2300 mm	≥ 2400 mm
2600 mm	≥ 2600 mm

Switchgear installation with rear pressure relief duct (option) for panel block with IAC A FL or FLR up to 16 kA/1 s

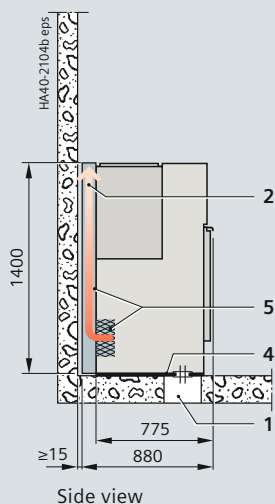

Switchgear installation with base and rear pressure relief duct (option) for panel block with IAC A FL or FLR up to 21 kA/1 s

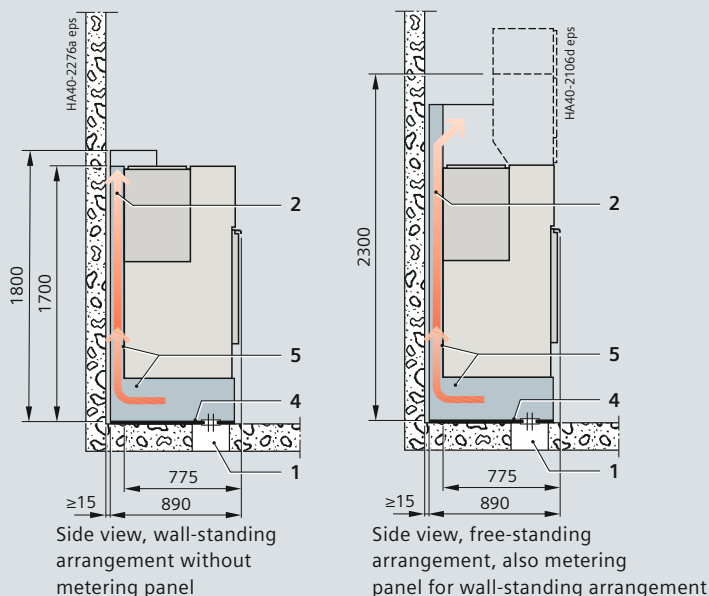

Dimensions

Room planning

For 8DJH Compact, the following types of pressure relief can be selected:

- Downwards into the cable basement for all feeders (internal arc classification up to IAC A FL or FLR 21 kA /1 s)
- Downwards into the cable basement for the ring-main feeders, and to the rear for the transformer feeders (internal arc classification up to IAC A F 21 kA /1 s).

The dimensions for wall distances, control aisles and cable basements correspond to those of the 8DJH Standard design. The pressure relief to the rear was tested with a rear wall distance of ≥ 3 m. This design is recommended for application in prefabricated substations without control aisle, with internal arcing test according to IEC 62271-202.

For 8DJH with outdoor enclosure (option), the direction of the pressure relief can be selected as follows:

- Downwards into the cable basement (internal arc classification up to IAC A FL or FLR 21 kA /1 s, minimum cross-section of the cable basement according to the illustration below)
- To the rear (internal arc classification up to IAC A FL 21 kA /1 s; for wall-standing arrangement, a rear pressure relief outlet with a minimum cross-section of 1 m^2 is required and must be supplied by the site)
- Upwards through rear pressure relief duct (internal arc classification up to IAC A FL or FLR 21 kA/1 s, free space above the switchgear 600 mm as a minimum).

The dimensions for wall distances, control aisles and cable basements correspond to those of the 8DJH Standard design. The outdoor enclosure is conceived for application on company ground.

Switchgear installation for 8DJH Compact with pressure relief downwards for all feeders (standard)

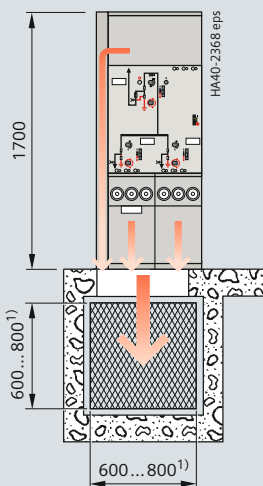

Switchgear installation for 8DJH Compact with pressure relief downwards for the ring-main feeders, and to the rear for the transformer feeders (option)

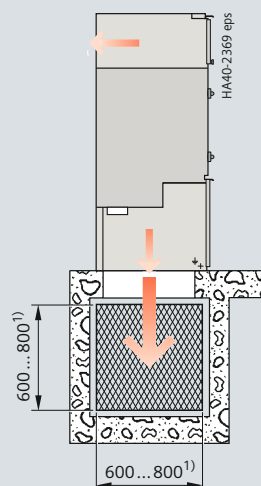

Switchgear installation for outdoor enclosure with pressure relief downwards

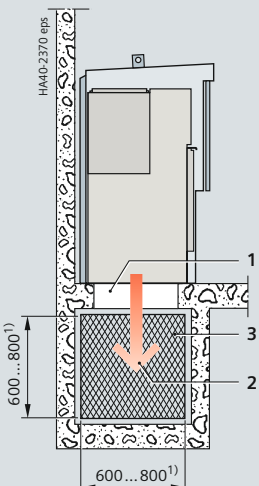

Switchgear installation for outdoor enclosure with pressure relief to the rear or upwards through rear duct

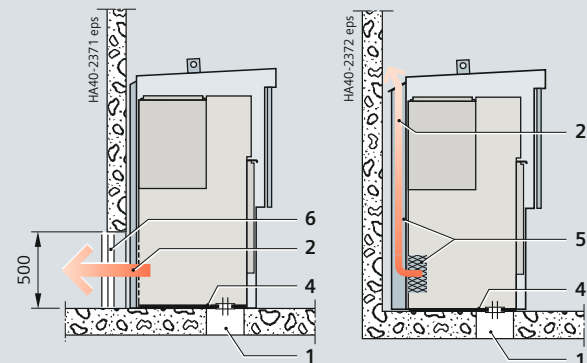

- 1 Floor opening
- 2 Direction of pressure relief
- 3 Expanded metal (supplied by site)
- 4 Pressure-resistant floor cover (divided plate for comfortable working at the cable connection)
- 5 Pressure absorber system with pressure relief duct

Cable feeder type K

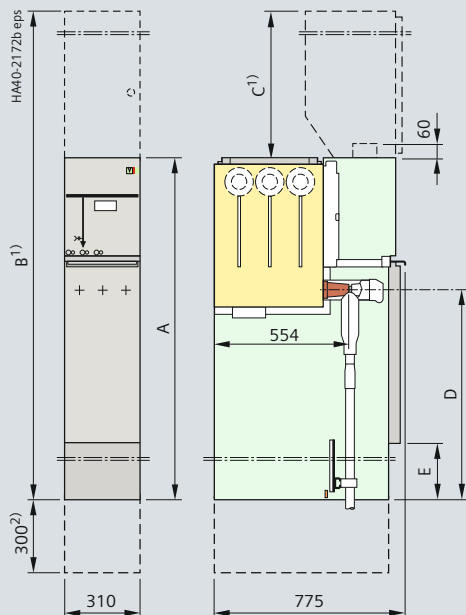

Ring-main feeder type R

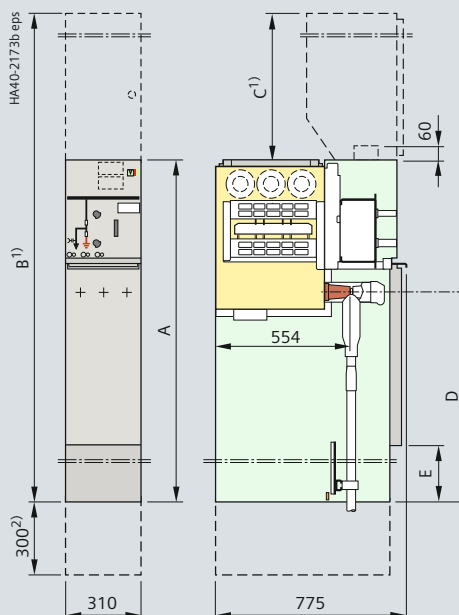

Switchgear height	without low-voltage compartment	A	1040 ³⁾	1200	1400
	with low-voltage compartment ¹⁾	B	–	see page 67	
Low-voltage compartment ¹⁾		C	–	200, 400, 600 or 900	
Cable connection	Typical K and R	D	500	660	860
Base cover		E	32	32	232

1) Option: With low-voltage compartment

2) Base for switchgear height of 1700 mm, or absorber --> cable connection height = D + 300 mm

3) Only for panel blocks RR, RRR, RT, RRT and RTR

Dimensions

Feeder panels (430 mm)

Cable feeder type K(E)
with make-proof earthing switch

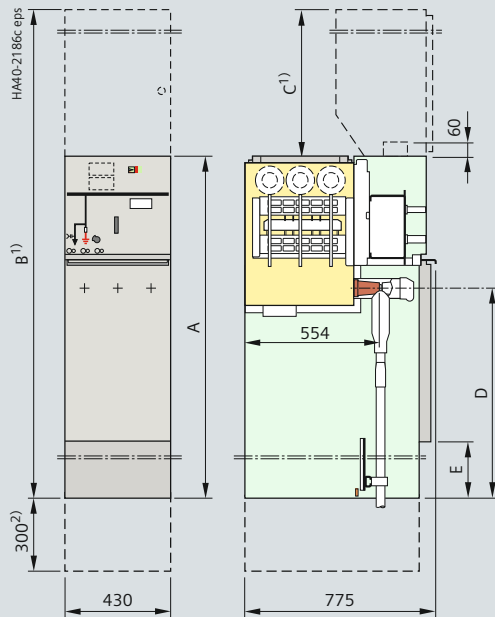

Transformer feeder type T

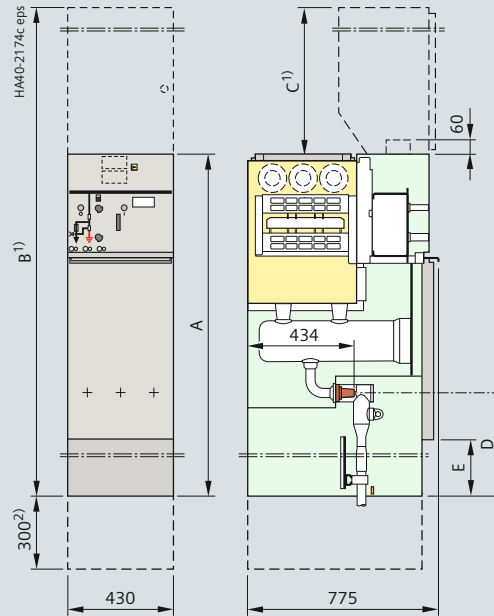

Circuit-breaker feeder type L

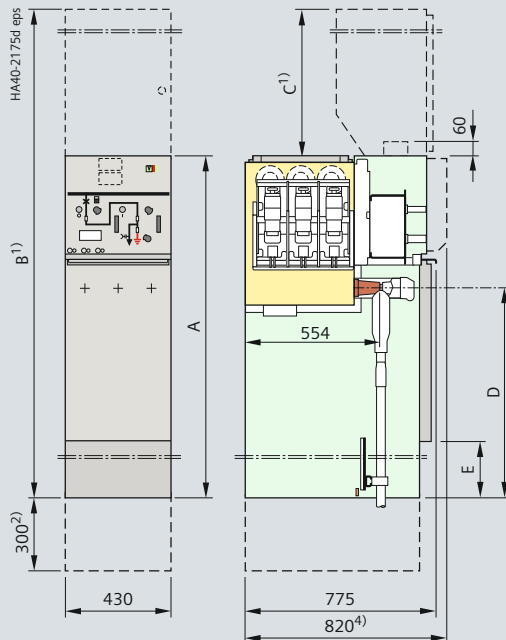

Switchgear height	without low-voltage compartment	A	1040 ³⁾	1200	1400
	with low-voltage compartment ¹⁾	B	–	see page 67	
Low-voltage compartment ¹⁾		C	–	200, 400, 600 or 900	
Cable connection	Typical K(E), L	D	–	660	860
	Typical T		62	222	422
Base cover		E	32	32	232

- 1) Option: With low-voltage compartment
 2) Base for switchgear height of 1700 mm, or absorber --> cable connection height = D + 300 mm

- 3) Only for panel blocks RR, RRR, RT, RRT and RTR
 4) Only for circuit-breaker type 1.1

Ring-main feeder type R(500)

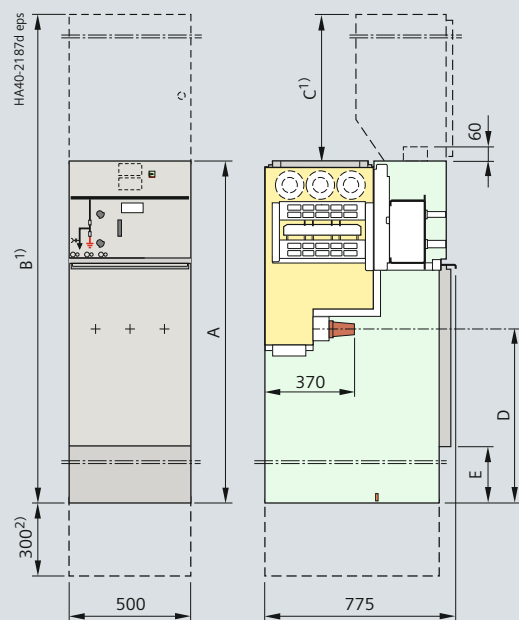

Circuit-breaker feeder type L(500)

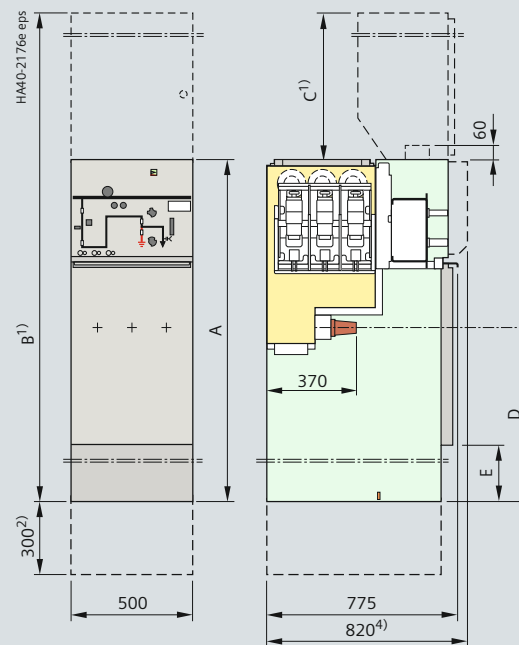

Design option with busbar voltage transformer for all circuit-breaker types

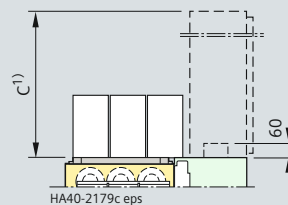

Switchgear height	without low-voltage compartment	A	1200	1400
	with low-voltage compartment ¹⁾	B	see page 67	
Low-voltage compartment ¹⁾		C	200, 400, 600 or 900	
Cable connection	Typical R(500), L(500)	D	510	710
Base cover		E	32	232

1) Option: With low-voltage compartment

4) Only for circuit-breaker type 1.1

2) Base for switchgear height of 1700 mm, or absorber --> cable connection height = D + 300 mm

Dimensions

Bus sectionalizer panels with switch-disconnector

Bus sectionalizer panel type S
with three-position switch-disconnector
and earthing on the right

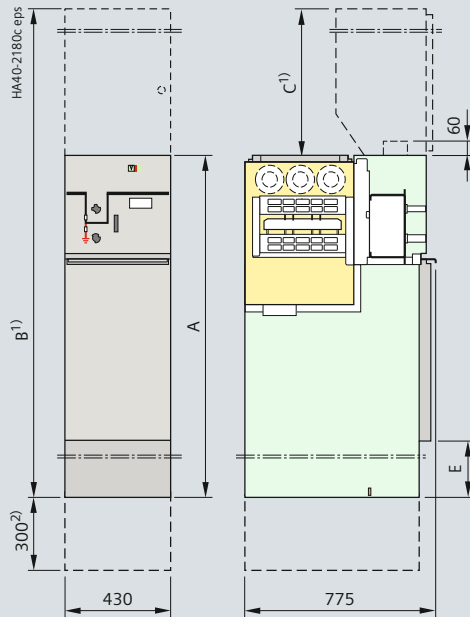

Bus sectionalizer panel type S(500)
with three-position switch-disconnector
and earthing on the right

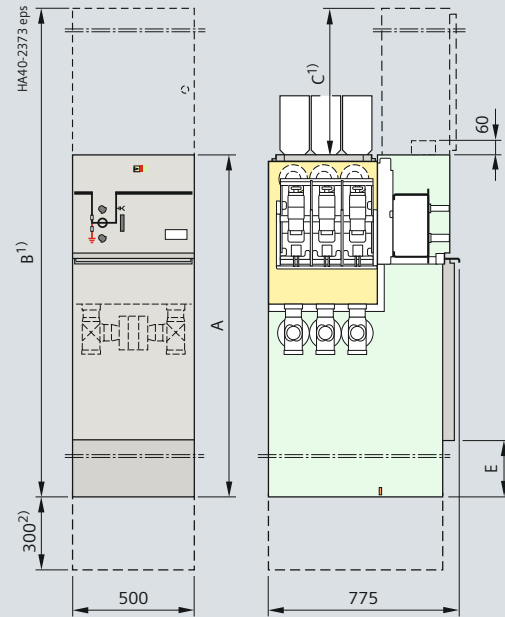

Bus sectionalizer panel type S(620)
with three-position switch-disconnector
and earthing on the left

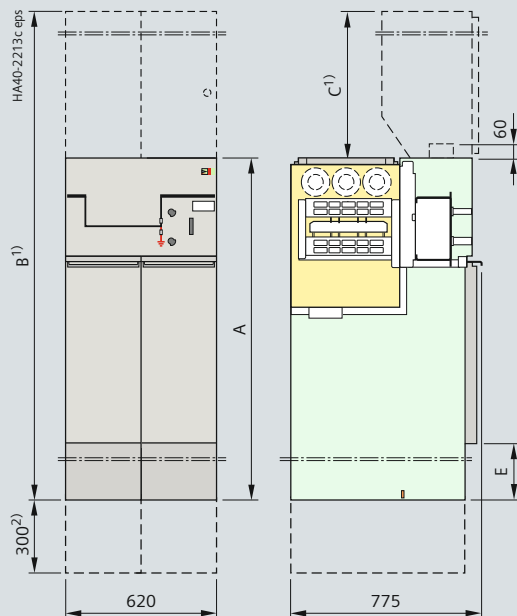

Bus sectionalizer panel type H
with switch-disconnector/fuse combination

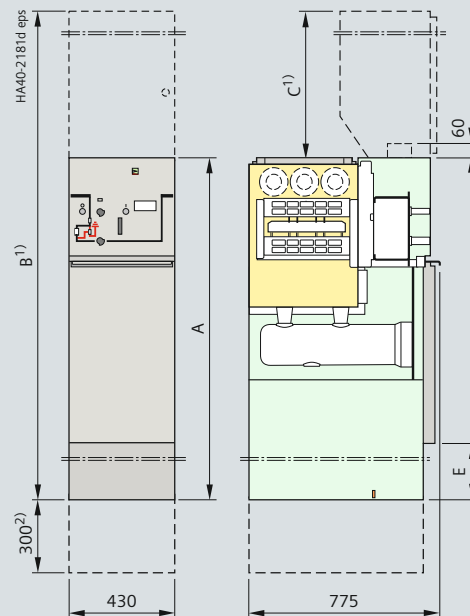

Switchgear height	without low-voltage compartment	A	1200	1400
	with low-voltage compartment ¹⁾	B	see page 67	
Low-voltage compartment ¹⁾	C	200, 400, 600 or 900		
Base cover	E	32	232	

1) Option: With low-voltage compartment

2) Base for switchgear height of 1700 mm, or absorber

Bus sectionalizer panel type V with circuit-breaker

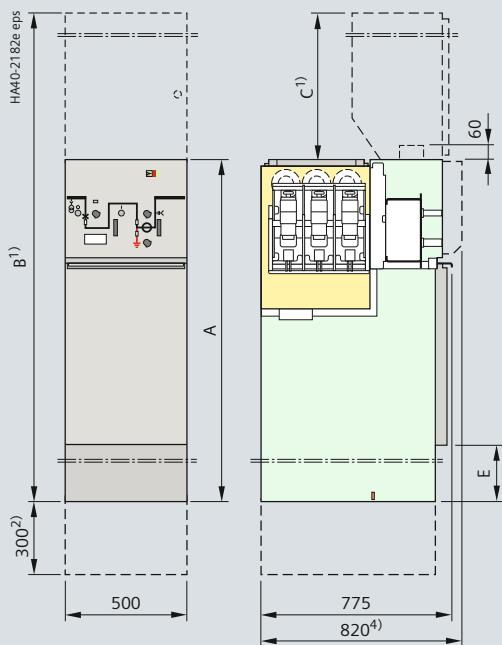

Design options with busbar voltage transformer and/or busbar current transformer

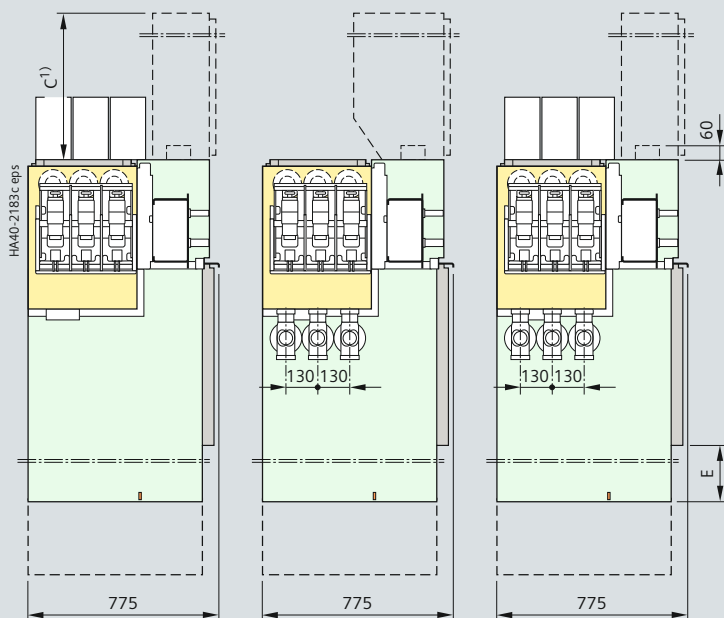

Switchgear height	without low-voltage compartment	A	1200	1400
	with low-voltage compartment ¹⁾	B	see page 67	
Low-voltage compartment ¹⁾		C	200, 400, 600 or 900	
Base cover		E	32	232

1) Option: With low-voltage compartment

4) Only for circuit-breaker type 1.1

2) Base for switchgear height of 1700 mm, or absorber

Dimensions

Busbar earthing panels and busbar voltage metering panels

Busbar earthing panel type E

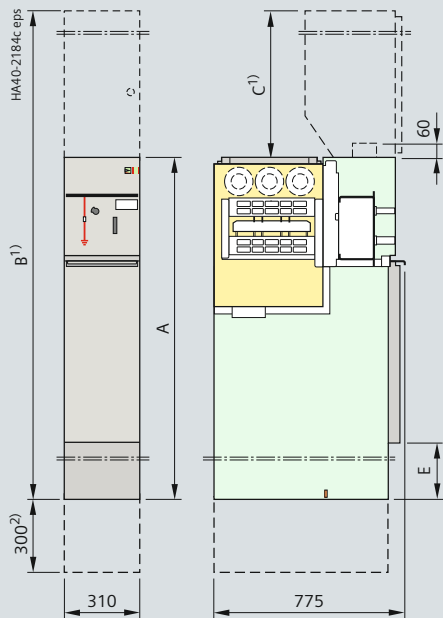

**Busbar earthing panel type E(500)
with voltage transformer**

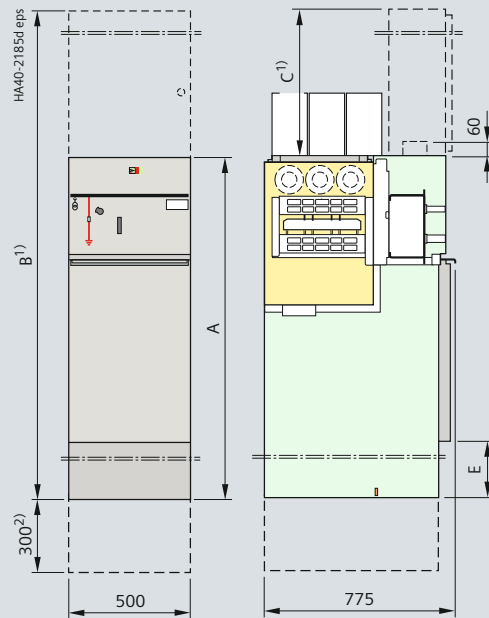

**Metering panel type M(500)
with disconnectable voltage transformer**

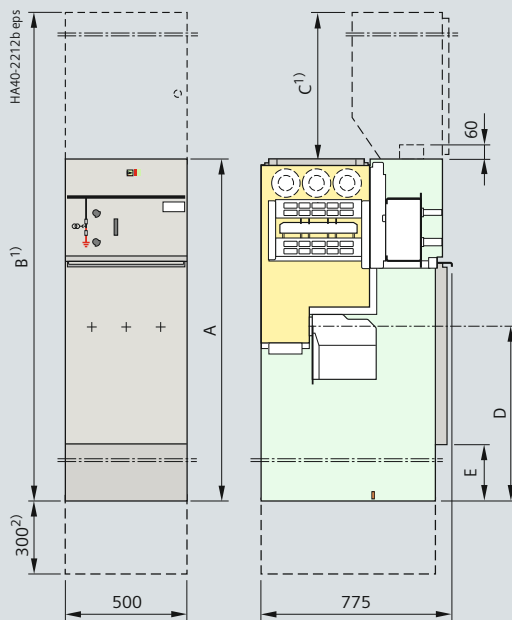

**Metering panel type M(430)
with disconnectable voltage transformer
fused on the primary side**

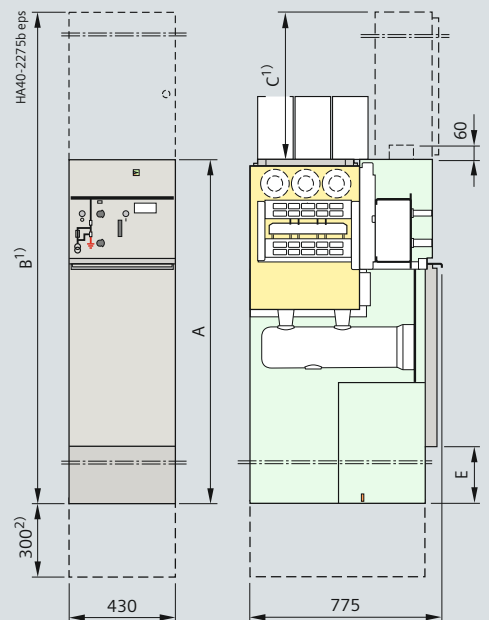

Switchgear height	without low-voltage compartment	A	1200	1400
	with low-voltage compartment ¹⁾	B	see page 67	
Low-voltage compartment ¹⁾		C	200, 400, 600 or 900	
Transformer connection	Typical M(500)	D	510	710
Base cover		E	32	232

1) Option: With low-voltage compartment

2) Base for switchgear height of 1700 mm, or absorber

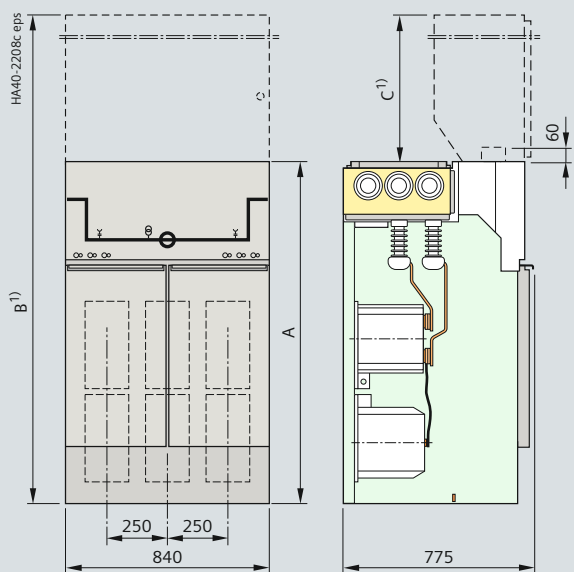

Connection: busbar – busbar

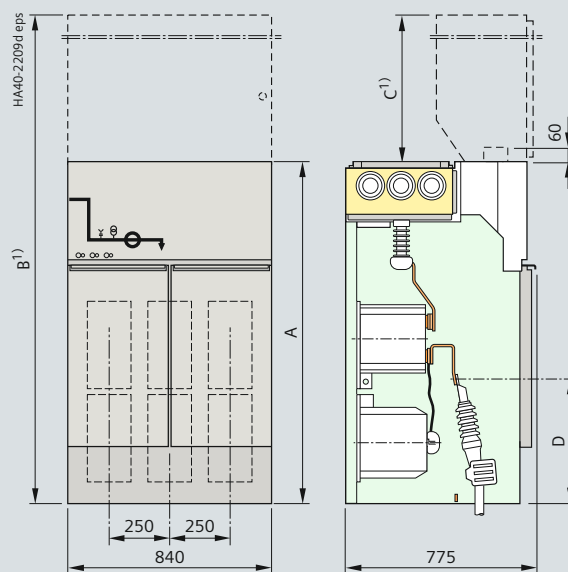

Connection: busbar on the left – cable on the right

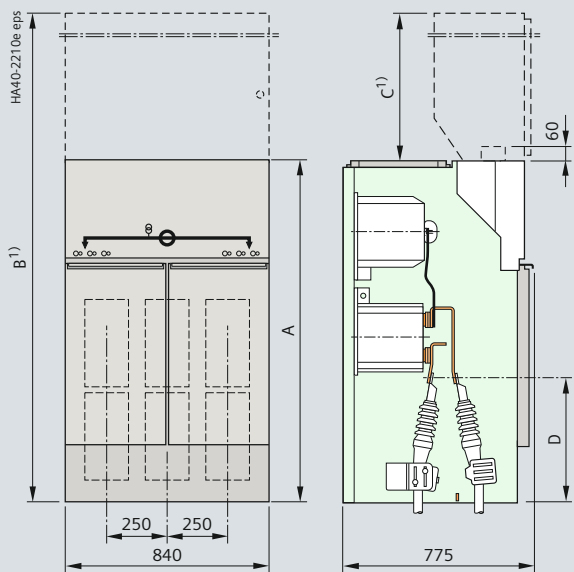

Connection: cable – cable

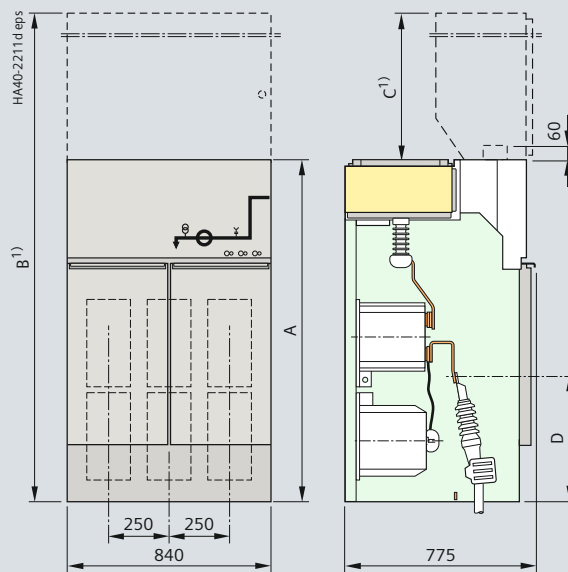

Connection: cable on the left – busbar on the right

Switchgear height	without low-voltage compartment	A	1400	
			without absorber base	with absorber base
	with low-voltage compartment ¹⁾	B	see page 67	
Low-voltage compartment ¹⁾		C	200, 400, 600 or 900	
Cable connection		D	515	815

1) Option: With low-voltage compartment

Dimensions

Panel blocks (preferred versions)

Versions with transformer feeders

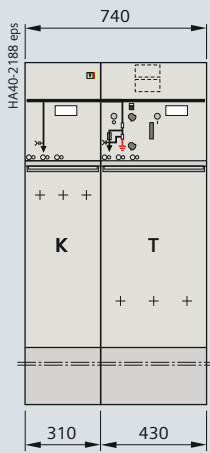

Panel block **KT**

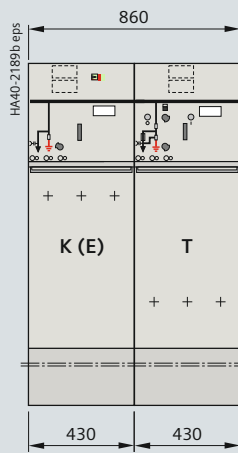

Panel block **K(E)T**

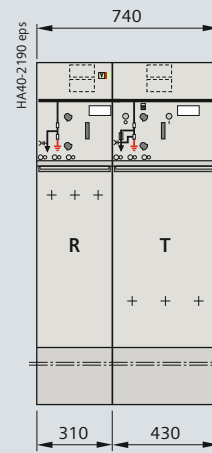

Panel block **RT**

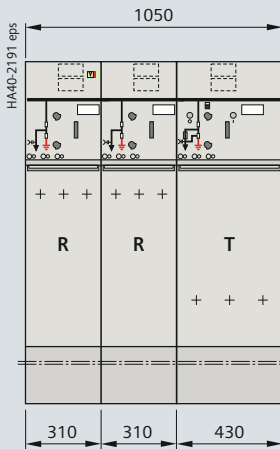

Panel block **RRT**

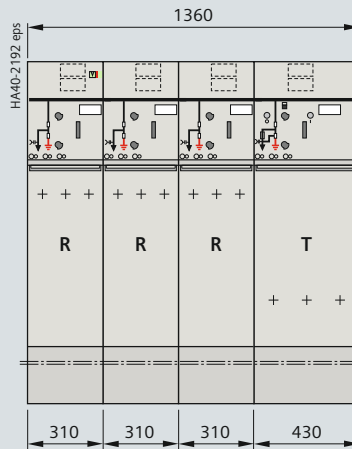

Panel block **RRRT**

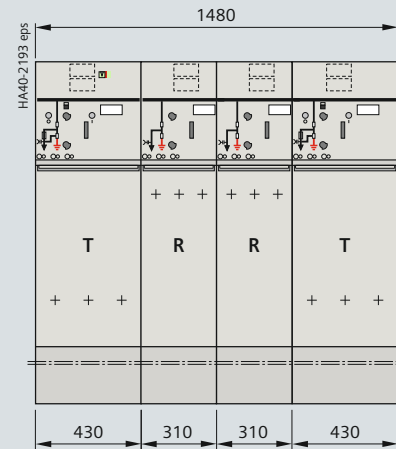

Panel block **TRRT**

For further dimension data,
see individual panels on pages 12 to 14

Overall height optionally 1200 mm, 1400 mm or 1700 mm
For floor openings and fixing points, see pages 83 to 86

Versions with circuit-breaker feeders

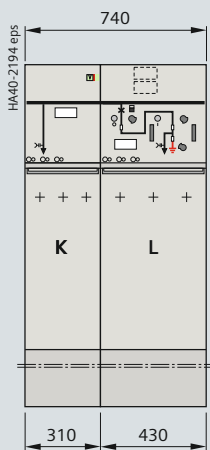

Panel block KL

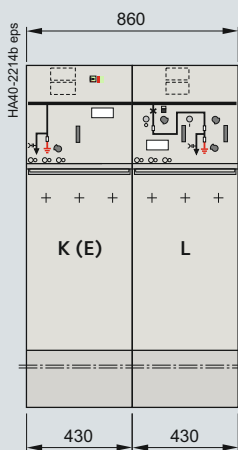

Panel block K(E)L

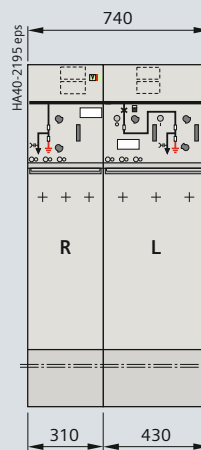

Panel block RL

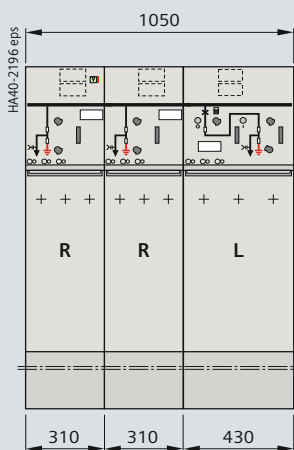

Panel block RRL

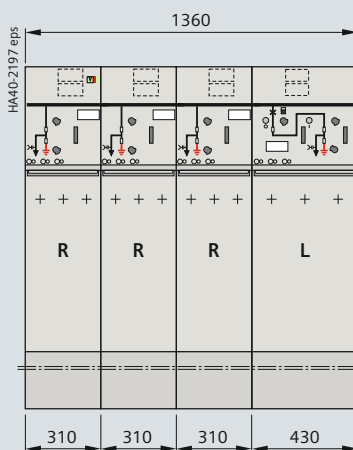

Panel block RRRL

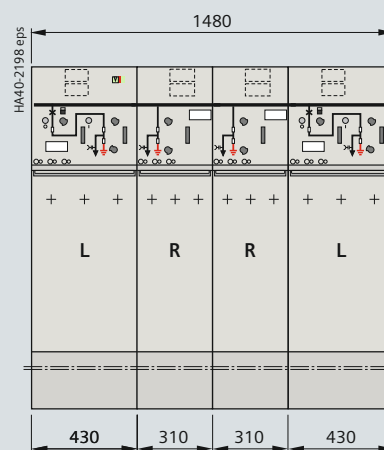

Panel block LRRL

For further dimension data,
see individual panels on pages 12 to 14

Overall height optionally 1200 mm, 1400 mm or 1700 mm
For floor openings and fixing points, see pages 83 to 86

Dimensions

Panel blocks (preferred versions)

Further versions

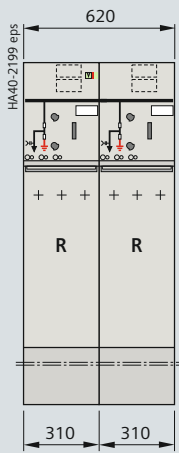

Panel block **RR**

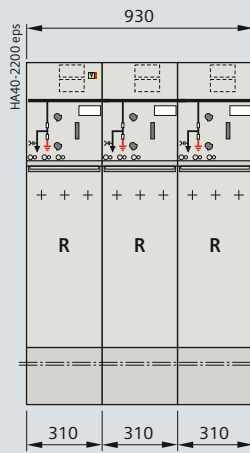

Panel block **RRR**

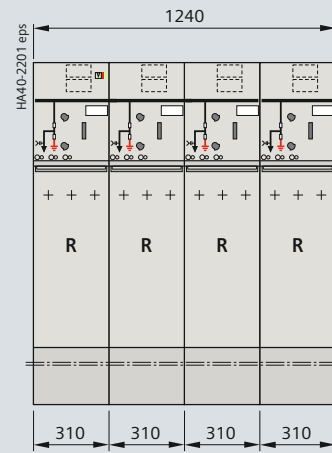

Panel block **RRRR**

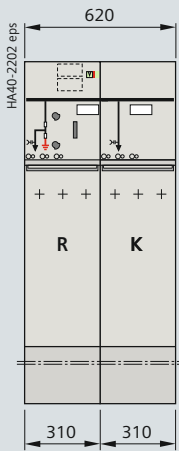

Panel block **RK**

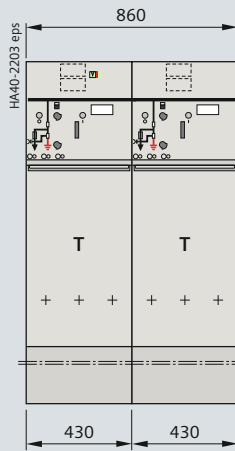

Panel block **TT**

For further dimension data,
see individual panels on pages 12 to 14

Overall height optionally 1200 mm, 1400 mm or 1700 mm
For floor openings and fixing points, see pages 83 to 86

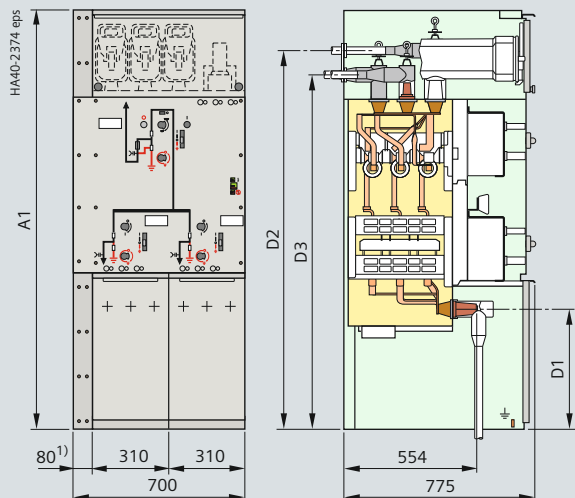

Panel block RRT compact

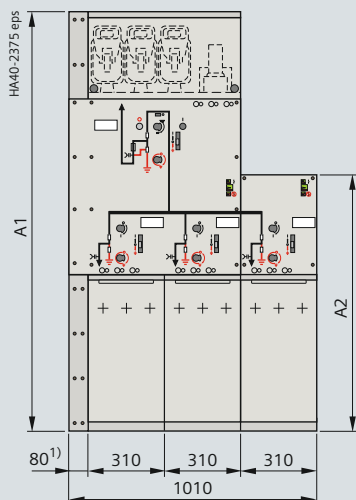

Panel block RRT-R Compact

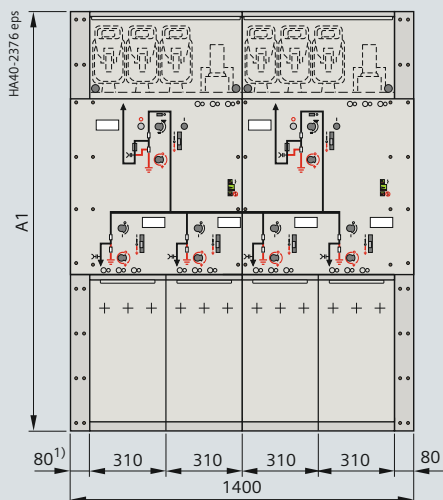

Panel block RRT-RRT Compact

Switchgear height		A ₁	1400	1700
		A ₂	740	1040
Cable connection	Typical R	D ₁	200	500
	Typical T	D ₂	1245	1545
		D ₁	1143	1443

1) Only for pressure relief downwards for all feeders (IAC A FLR up to 21 kA/1 s)

Dimensions

Panel blocks (freely configurable)

Panel blocks with common gas-filled vessel are possible for

- Up to 4 functions in one block
- Functions in 310 mm and 430 mm panel widths
- Functions R and T in any arrangement
- Functions R and L in any arrangement
- Optionally for overall heights 1200 mm, 1400 mm and 1700 mm

Examples

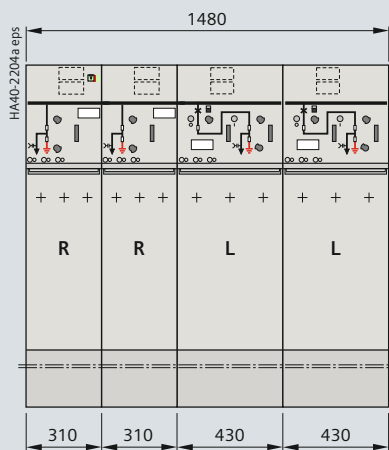

Panel block **RRLL**

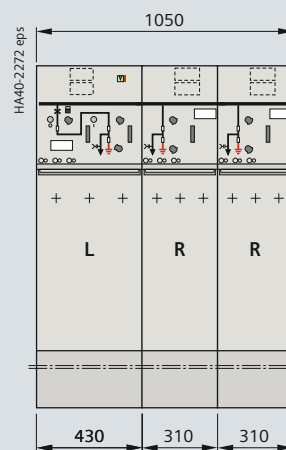

Panel block **LRR**

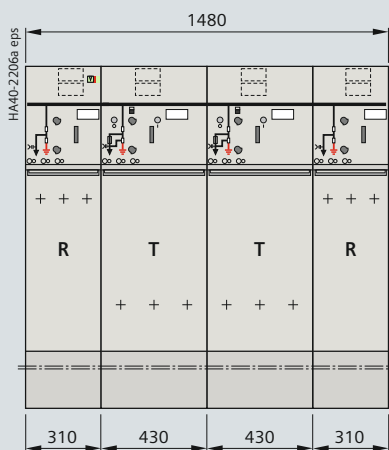

Panel block **RTTR**

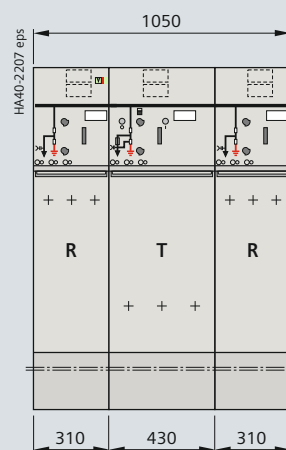

Panel block **RTR**

Further panel block versions can be supplied without functional restrictions up to a total width of 2 m as an assembled and tested unit.

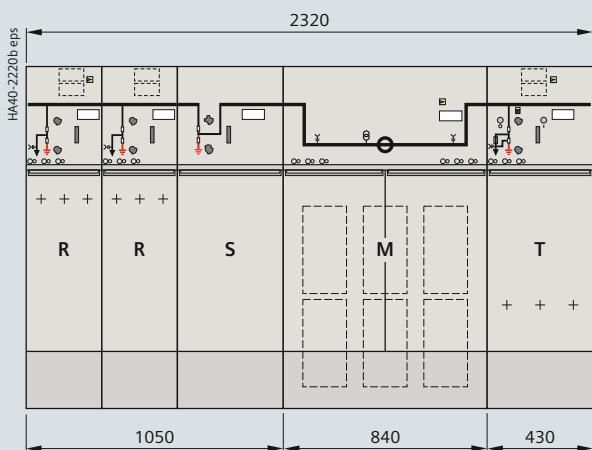

Transfer with ring-main switch (RRS-M-T...)

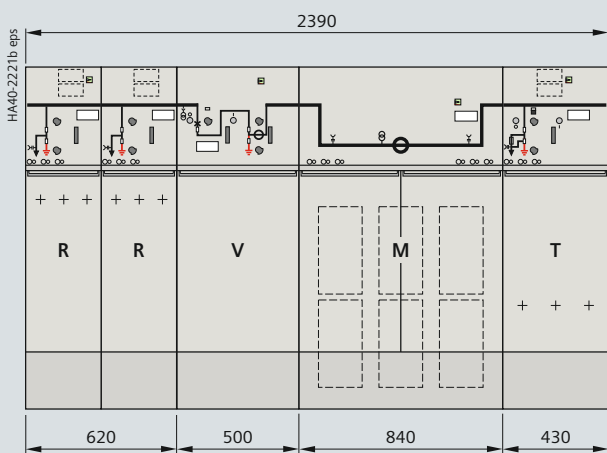

Transfer with circuit-breaker without cables (RR-V-M-T...)

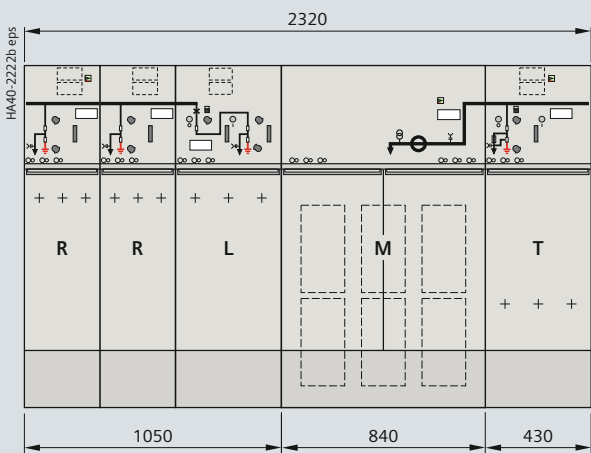

Transfer with circuit-breaker in the panel block and cable connection (RRL-M-T...)

Dimensions

Outdoor enclosure

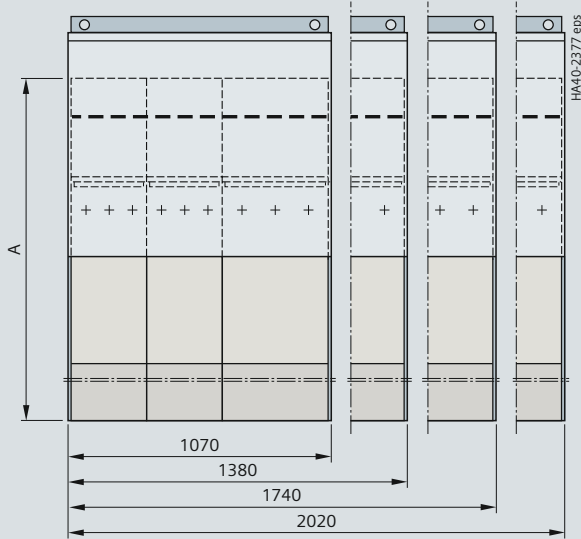

Outdoor enclosure with pressure relief downwards or to the rear

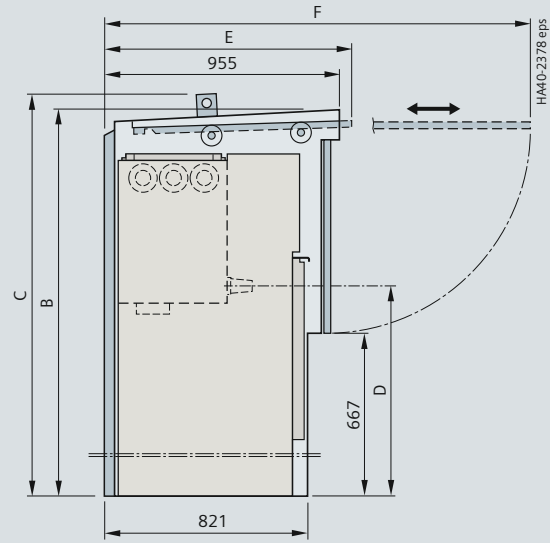

Outdoor enclosure with pressure relief downwards or to the rear

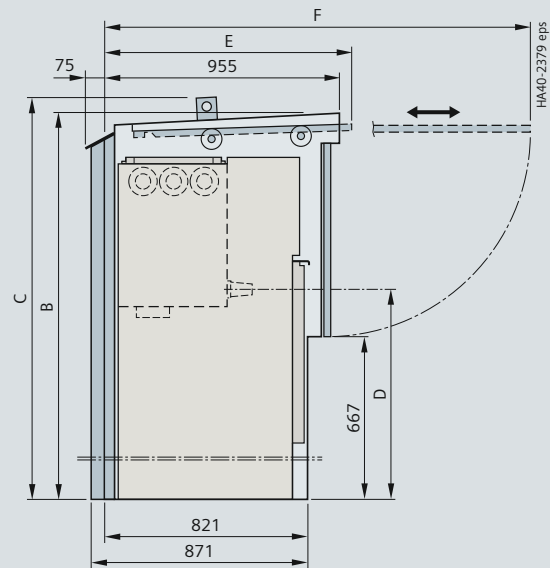

Outdoor enclosure with pressure relief upwards

Switchgear height	without low-voltage compartment		A							
	with low-voltage compartment ¹⁾		1200			1400				
Low-voltage compartment ¹⁾	-	-	1400	1600	1800	-	200	400		
Enclosure height	without crane height		B	1575	1575	1775	1975	1575	1775	1975
	with crane profile (removable)		C	1640	1640	1840	2040	1640	1840	2040
Cable connection	Typical K, K(E), R, L		D	660			860			
	Typical T			222			422			
	Typical R(500), L(500)			510			710			
Enclosure depth (roof level) Pressure relief downwards/ to the rear	Pressure relief downwards/to the rear	Door open	E	1000	1000	1200	1400	1000	1200	1400
		Door while opening/closing	F	1725	1725	1925	2125	1725	1925	2125
	Pressure relief upwards	Door open	E	1025	1025	1225	1425	1025	1225	1425
		Door while opening/closing	F	1750	1750	1950	2050	1750	1950	2050

1) Option: With low-voltage compartment

Note: Maximum switchgear width = Enclosure width - 20 mm

Standard *)

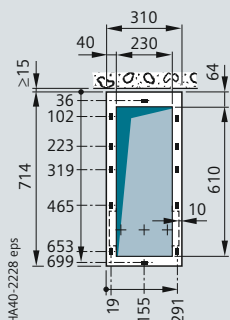

- For ring-main panel type R
- For cable panel type K
- For busbar earthing panel type E

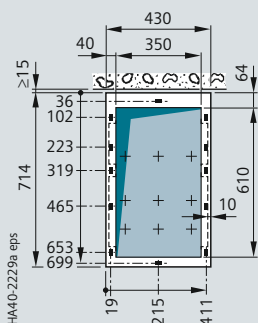

- For cable panel with make-proof earthing switch type K(E)
- For circuit-breaker panel type L
- For transformer panel type T
- For bus sectionalizer panel type S with switch-disconnector
- For bus sectionalizer panel type H with switch-disconnector/fuse combination
- For busbar voltage metering panel type M(430)

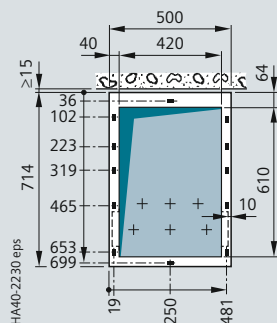

- For ring-main panel type R(500)
- For circuit-breaker panel type L(500)
- For busbar earthing panel type E(500)
- For bus sectionalizer panel type S(500) with switch-diconnector
- For bus sectionalizer panel type V with circuit-breaker
- For busbar voltage metering panel type M(500)

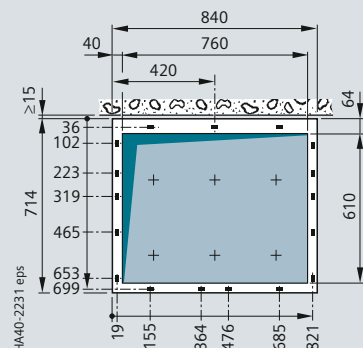

- For billing metering panel type M

*) For panel versions with double cables and deep cable compartment cover, as well as for other versions, please order the dimension drawings.

Dimensions

Floor openings and fixing points

Standard *) panel blocks

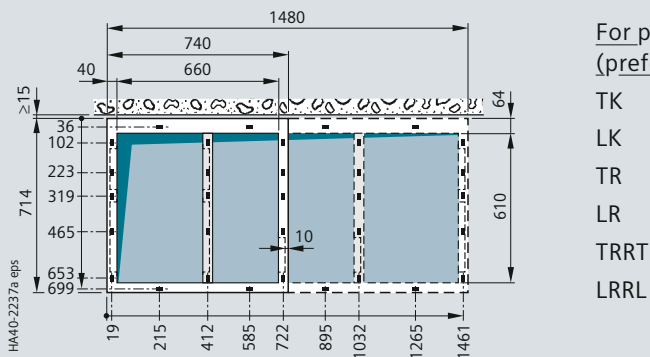
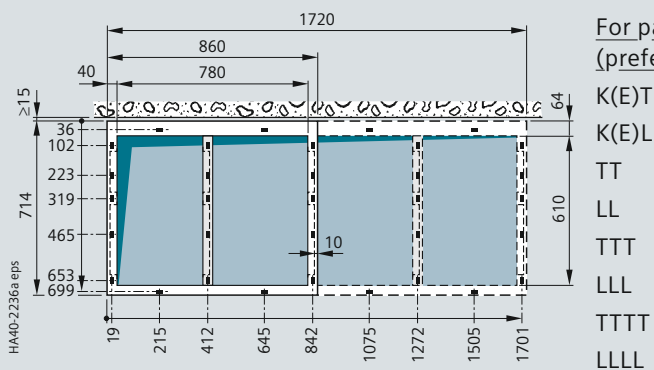
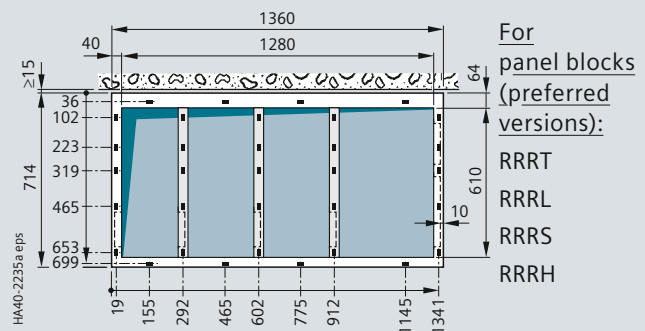
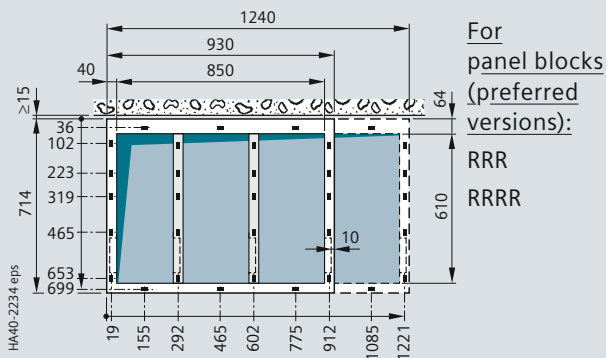
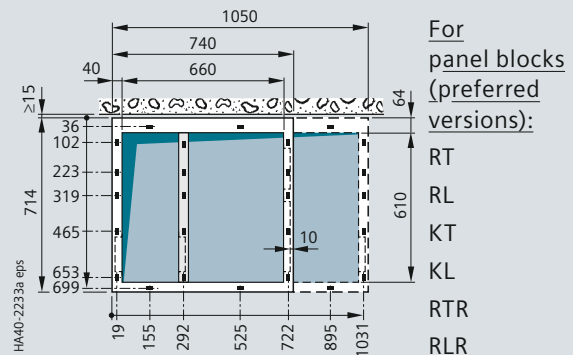
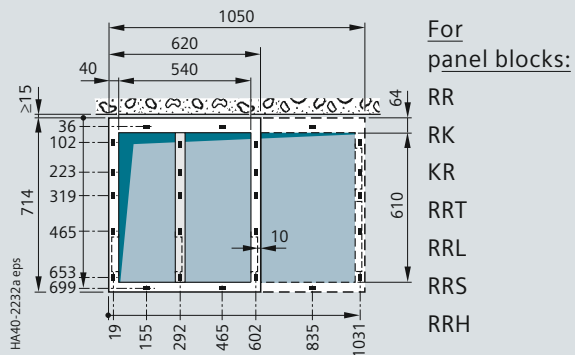

*) For panel versions with double cables and deep cable compartment cover, as well as for other versions, please order the dimension drawings.

Panel blocks 8DJH Compact

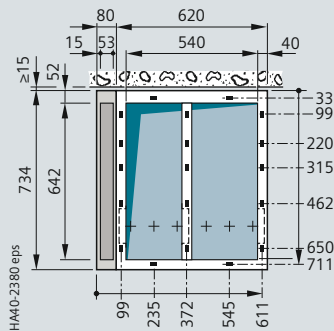

Panel block RRT Compact

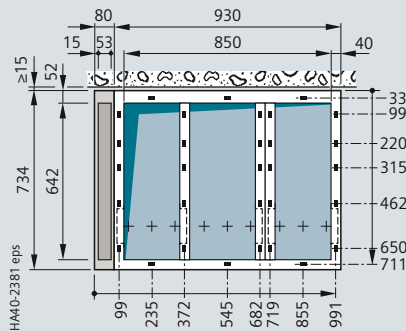

Panel block RRT-R Compact

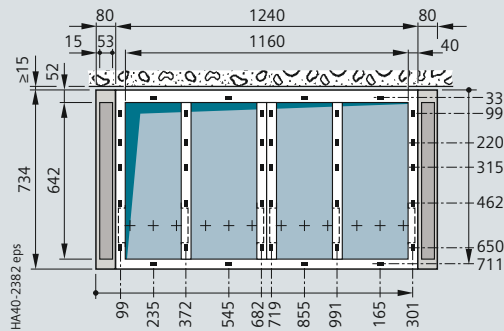

Panel block RRT-RRT Compact

Versions with deep cable compartment covers (e.g. for double cable connections)

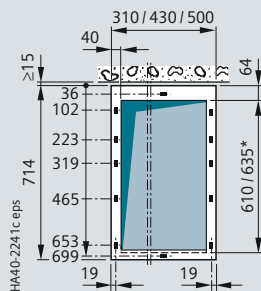

Deep cable compartment cover:
Without

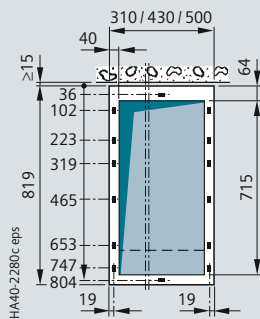

With base extension
(floor opening depending on selected cable connection/arrester)
Deeper by 105 mm

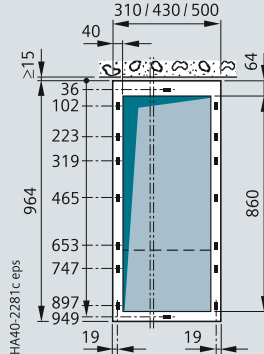

Deeper by 250 mm

Example:

Position of floor openings and fixing points for double cable connection for panel blocks

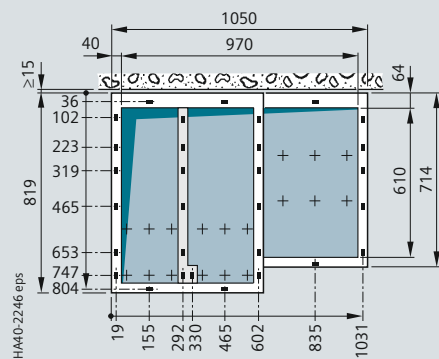

Type RRT deeper by 105 mm

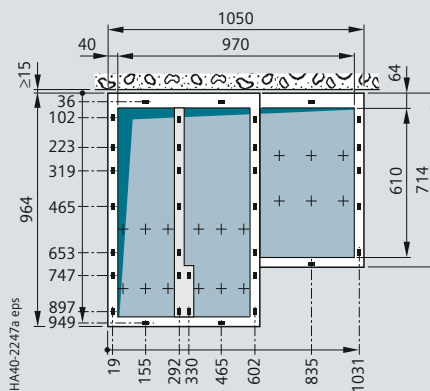

Type RRT deeper by 250 mm

* 610 mm for single cable connection; 635 mm for double cable connection with coupling T-plug
For concrete switchgear versions, please order the dimension drawings.

Dimensions

Floor openings and fixing points

Versions in connection with base and rear pressure relief duct for switchgear with IAC A FL or FLR up to 21 kA/1 s and deep cable compartment covers**

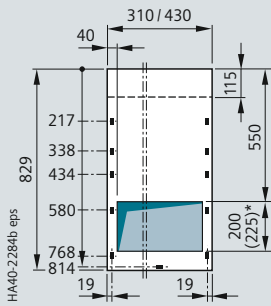

Deep cable compartment cover:
Without

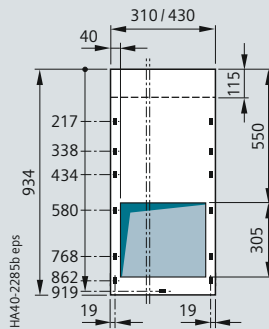

With base extension
(floor opening depending on selected cable connection/arrester)
Deeper by 105 mm

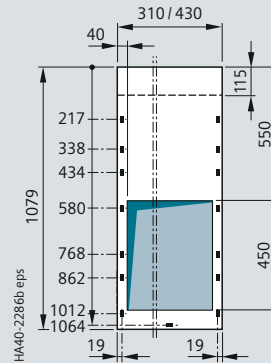

Deeper by 250 mm

- For ring-main panel type R
- For cable panel type K
- For cable panel type K(E) with make-proof earthing switch
- For circuit-breaker panel type L

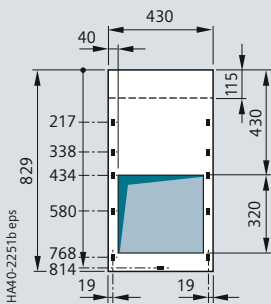

- For transformer panel type T

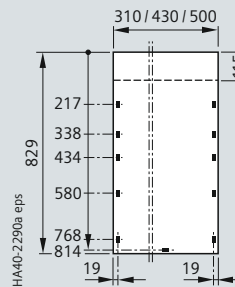

- For panels without cable feeder types S, H, V, M(430)/(500), E, E(500)

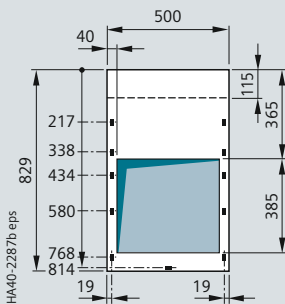

- For ring-main panel type R(500)
- For circuit-breaker panel type L(500)

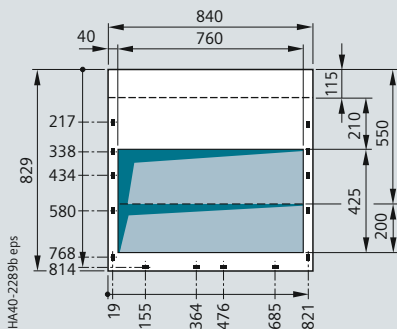
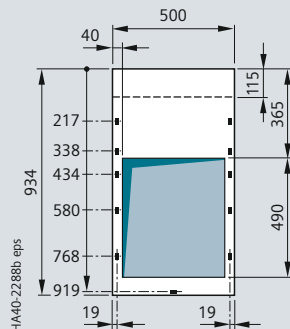

- For billing metering panel type M

* 200 mm for single cable connection; 225 mm for double cable connection with coupling T-plug

** In versions with rear pressure relief duct for panel block with IAC A FL or FLR up to 16 kA/1 s, the depth is reduced by 10 mm.

For wall-standing arrangement, a wall distance of ≥ 15 mm must be provided.

For concrete switchgear versions, please order the dimension drawings.

Packing types (examples)

For size and weight of the transport units, see the following tables.

Means of transport	Examples for packing
Rail and truck	Type: Open PE protective foil pulled over the switchgear, with wooden base
Seafreight	Type: Open (for container transport) PE protective foil pulled over the switchgear, with wooden base
	Type: Seaworthy crate (for open-top container) Welded PE protective foil, with closed wooden crate, with desiccant bag
Airfreight	Type: Open PE protective foil pulled over the switchgear, with wooden base and lattice or cardboard cover

Transport

8DJH switchgear is completely delivered in transport units. Please observe the following:

- Transport facilities on site
- Transport dimensions and weights
- Size of door openings in building
- Switchgear with low-voltage compartment: Please observe other transport dimensions and weights.

Transport dimensions

Max. width of switchgear unit TE	Transport dimensions				
	Truck/rail/container			Seaworthy crate / airfreight	
	Width B	Height	Depth T	Height	Depth T
mm	m	m	m	m	m
850	1.10	A + 0.20	1.10 / 1.26 *)	A + 0.4	1.10 / 1.26 *)
1200	1.45			min. 2.00	
1550	1.80				
1800	2.05				
2300	2.55				

A = Switchgear height with or without low-voltage compartment

*) Deeper transport base required in case of cable compartment cover deeper by 250 mm

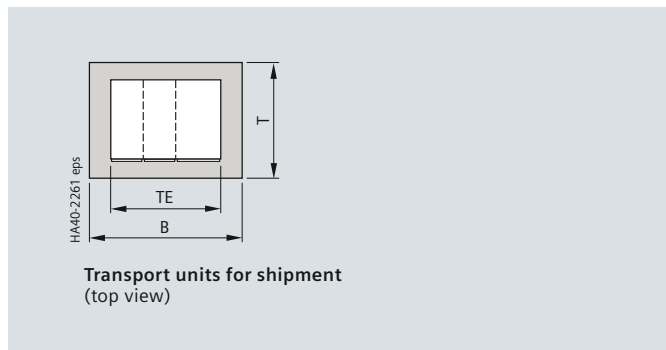

Types of transport (examples)

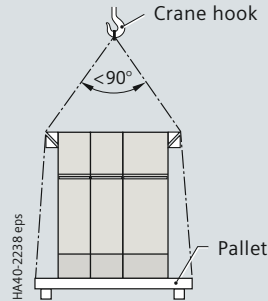

Crane transport with Pallet

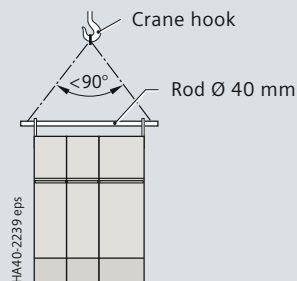

Crane transport with rod

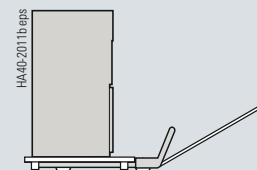

Transport with lifting truck with or without pallet

Rod \varnothing 40 mm
(observe switchgear weight)

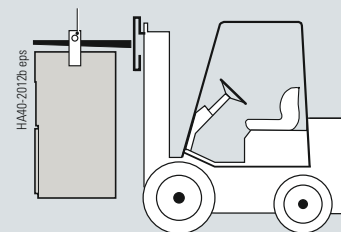

Transport with fork-lift truck, suspended

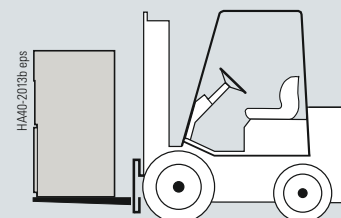

Transport with fork-lift truck, standing

Installation

Shipping data, transport

Transport weights

The transport weight results from the switchgear weight per transport unit and the packing weight. The packing weight results from the transport dimensions and the type of transport.

Switchgear weights

The weight of the switchgear unit results from the sum of the weights per functional unit. Depending on the design and the degree to which it is equipped (e.g. current transformers, motor operating mechanism, low-voltage compartment), different values will result. The table shows mean values.

Panel type	Width mm	Gross weight for switchgear height			LV com- partment
		1200 mm	1400 mm	1700 mm	600 mm
		approx. kg	approx. kg	approx. kg	approx. kg
R	310	100	110	120	40
R(500)	500	140	150	170	60
K	310	100	110	120	40
K(E)	430	130	140	160	50
T	430	135	145	160	50
L	430	130	140	155	50
L (type 1.1) without 4MT3	500	210	220	240	60
L (type 2)	500	160	170	190	60
M (BC / BB / CB)	840	–	370	400	70
M (CC)	840	–	270	300	70
M(430) with 3x4MT3	430	220	230	245	40
M(500) with 3x4MT3	500	230	240	260	60
S	430	130	140	160	50
S(500)	500	150	160	180	60
S(620)	620	200	220	240	2x40
H	430	135	145	160	50
V	500	240	250	270	60
E	310	100	110	120	40
E(500)	500	140	150	170	60

Additional weights for pressure absorber

For panel blocks IAC A FL/FLR up to 16 kA / 1 s
Basic switchgear height 1400 mm

	Weight / kg
Cooler	30
Duct 16 kA FL/FLR	60
Base plate per panel	approx. 5
<i>Example</i> RRT with IAC A FL/FLR 16 kA/1 s	105

For switchgear IAC A FL/FLR up to 21 kA / 1 s
Basic switchgear height 1700 mm

	Weight / kg
Cooler	30
Duct 21 kA FL	70
Duct 21 kA FLR	75
Absorber collar FLR	20
Base plate per panel	approx. 5
<i>Example</i> RRT with IAC A FL 21 kA/1 s RRT with IAC A FLR 21 kA/1 s Metering panel with IAC A FL/FLR 21 kA/1 s	115 140 145

Panel block	Width mm	Gross weight for switchgear height without LV compartment		
		1200 mm	1400 mm	1700 mm
		approx. kg	approx. kg	approx. kg

2 panels

KT, TK	740	230	250	280
K(E)T	860	240	260	290
KL ¹⁾ , LK	740	230	250	280
K(E)L ¹⁾	860	250	270	300
RK, KR	620	200	220	240
RT, TR	740	230	250	280
RL ¹⁾ , LR	740	230	250	280
TT	860	270	290	320
RR	620	200	220	240
LL ¹⁾	860	260	280	310
RS	740	230	250	280
RH	740	230	250	280

3 panels

RRT	1050	330	360	400
RRL ¹⁾	1050	320	350	390
RTR	1050	330	360	400
RLR	1050	320	350	390
RRR	930	300	330	360
TTT	1290	410	440	490
LLL ¹⁾	1290	400	430	480
RRS	1050	320	350	390
RRH	1050	330	360	400

4 panels

RRRT	1360	430	470	520
RRRL ¹⁾	1360	430	470	520
RRRR	1240	400	440	480
TRRT	1480	470	510	560
LRRL	1480	460	500	550
TTTT	1720	540	580	640
LLLL ¹⁾	1720	520	560	620
RRRS	1360	420	460	510
RRRH	1360	430	470	520

8DJH Compact

Panel block	Width mm	Gross weight for switchgear height	
		1400 mm	1700 mm
		approx. kg	approx. kg
RRT ²⁾	700	365	380
RRT	620	340	345
RRT-R ²⁾	1010	475	490
RRT-R	930	450	455
RRT-RRT ²⁾	1400	730	760
RRT-RRT	1240	860	690

1) Weight data applies to design with circuit-breaker type 2

2) With lateral pressure relief duct

Packing weights

Max. width of switchgear unit mm	Packing weight Truck / rail / container approx. kg	Packing weight Seaworthy crate / airfreight approx. kg
850	30	90
1200	40	120
1550	50	150
1800	60	180
2000	75	225

Standards

8DJH switchgear complies with the relevant standards and specifications applicable at the time of type tests.

In accordance with the harmonization agreement reached by the countries of the European Union, their national specifications conform to the IEC standard.

Type of service location

8DJH switchgear can be used as indoor installation according to IEC/EN 61936 (Power Installations exceeding AC 1 kV) and VDE 0101.

- Outside lockable electrical service locations at places which are not accessible to the public. Enclosures of switchgear can only be removed with tools.
- Inside lockable electrical service locations. A lockable electrical service location is a place outdoors or indoors that is reserved exclusively for housing electrical equipment and which is kept under lock and key. Access is restricted to authorized personnel and persons who have been properly instructed in electrical engineering. Untrained or unskilled persons may only enter under the supervision of authorized personnel or properly instructed persons.

Terms

"Make-proof earthing switches" are earthing switches with short-circuit making capacity according to IEC/EN 62271-102 and VDE 0671-102.

Dielectric strength

- The dielectric strength is verified by testing the switchgear with rated values of short-duration power-frequency withstand voltage and lightning impulse withstand voltage according to IEC/EN 62271-1/VDE 0671-1.
- The rated values are referred to sea level and to normal atmospheric conditions (1013 hPa, 20 °C, 11 g/m³ humidity according to IEC/EN 60071 and VDE 0111).
- The dielectric strength decreases with increasing altitude. For site altitudes above 1000 m (above sea level) the standards do not provide any guidelines for the insulation rating, but leave this to the scope of special agreements.

All parts housed inside the switchgear vessel which are subjected to high voltage are SF₆-insulated against the earthed enclosure.

The gas insulation at a relative gas pressure of 50 kPa (= 500 hPa) permits switchgear installation at any desired altitude above sea level without the dielectric strength being adversely affected. This also applies to the cable connection when using screened cable T-plugs or cable elbow plugs.

A decrease (reduction) of the dielectric strength with increasing site altitude must be considered for panels with HV HRC fuses as well as for air-insulated metering panels and a site altitude above 1000 m (above sea level). A higher insulation level must be selected, which results from the multiplication of the rated insulation level for 0 to 1000 m with the altitude correction factor K_a .

Overview of standards (July 2013)

		IEC/EN-Standard	VDE-Standard
Switchgear	8DJH	IEC/EN 62271-1	VDE 0671-1
		IEC/EN 62271-200	VDE 0671-200
Devices	Circuit-breakers	IEC/EN 62271-100	VDE 0671-100
	Disconnectors and earthing switches	IEC/EN 62271-102	VDE 0671-102
	Switch-disconnectors	IEC/EN 62271-103	VDE 0671-103
	Switch-disconnector / fuse combination	IEC/EN 62271-105	VDE 0671-105
	HV HRC fuses	IEC/EN 60282-1	VDE 0670-4
	Voltage detecting systems	IEC/EN 61243-5	VDE 0682-415
Degree of protection	–	IEC/EN 60529	VDE 0470-1
Insulation	–	IEC/EN 60071	VDE 0111
Instrument transformers	Current transformers	IEC/EN 61869-1/-2	VDE 0414-9-1/-2
	Voltage transformers	IEC/EN 61869-1/-3	VDE 0414-9-1/-3
	Electronic voltage transformers	IEC/EN 61869-7	VDE 0414-44-7
	Electronic current transformers	IEC/EN 61869-8	VDE 0414-44-8
Installation, erection	–	IEC/EN 61936-1 HD 637-S1	VDE 0101

Altitude correction factor K_a for panels with HV HRC fuses or for metering panels type M

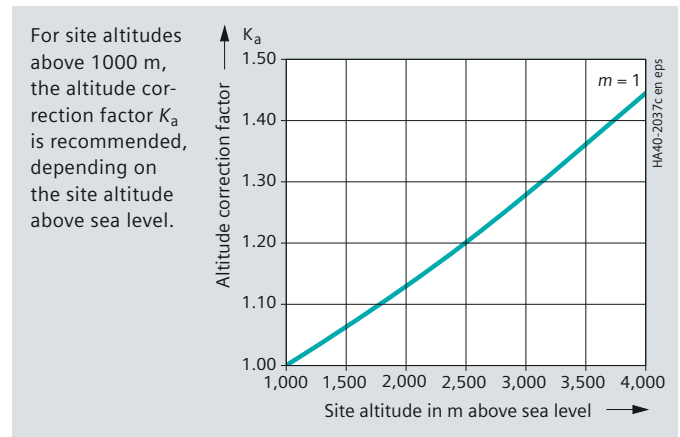

Curve $m = 1$ for rated short-duration power-frequency withstand voltage and rated lightning impulse withstand voltage according to IEC/EN 62271-1/VDE 0671-1.

Example:

3000 m site altitude above sea level
17.5 kV switchgear rated voltage,
95 kV rated lightning impulse withstand voltage

Rated lightning impulse withstand voltage to be selected $95 \text{ kV} \cdot 1.28 = 122 \text{ kV}$

Result:

According to the above table, a switchgear for a rated voltage of 24 kV with a rated lightning impulse withstand voltage of 125 kV is to be selected.

Standards

Standards, specifications, guidelines

Current carrying capacity

- According to IEC/EN 62271-200/VDE 0671-200 or IEC/EN 62271-1/VDE 0671-1, the rated normal current refers to the following ambient air temperatures:
 - Maximum of 24-hour mean + 35 °C
 - Maximum + 40 °C
- The current carrying capacity of the panels and busbars depends on the ambient air temperature outside the enclosure.

Appearance of internal faults

In gas-insulated switchgear 8DJH, faults leading to internal arcing are widely excluded by construction due to the following measures:

- Use of gas-filled switchgear compartments
- Use of suitable operational equipment such as three-position switches with make-proof earthing switch
- Logical mechanical interlocks
- Use of metal-coated or metal-enclosed voltage transformers and three-phase current transformers as ring-core current transformers
- There are no effects due to external influences, such as
 - Pollution layers
 - Humidity
 - Small animals and foreign objects
- Maloperation is practically excluded due to logical arrangement of operating elements
- Short-circuit-proof feeder earthing by means of the three-position switch-disconnector.

In the event of an arc fault at the cable connection or, in an unlikely case, inside the switchgear vessel, pressure relief is effected downwards into the cable basement.

For the use in substation buildings without internal arcing test, such as “old substations”, the switchgear can be designed with a modified pressure relief system with absorbers (option).

As a “special cooling system”, this maintenance-free pressure absorber system reduces the pressure-dependent and thermal effects of internal arcing in switchgear vessels and cable compartments, and thus protects people and buildings.

The closed switchgear system is suitable for both wall-standing and free-standing arrangement.

Internal arcing test (design option)

- Protection of operating personnel by means of tests for verifying the internal arc classification
- Internal arcing tests must be performed in accordance with IEC/EN 62271-200/VDE 0671-200 for IAC (internal arc classification)
- Definition of criteria:
 - Criterion 1
Correctly secured doors and covers do not open, limited deformations are accepted

- Criterion 2
No fragmentation of the enclosure, no projection of small parts above 60 g
 - Criterion 3
No holes in accessible sides up to a height of 2 m
 - Criterion 4
No ignition of indicators due to hot gases
 - Criterion 5
The enclosure remains connected to its earthing point.
- Optionally, 8DJH switchgear can be designed with internal arc classification.

Seismic withstand capability (option)

8DJH switchgear can be upgraded for regions at risk from earthquakes. For upgrading, earthquake qualification testing has been carried out in accordance with the following standards:

- IEC/EN 60068-3-3
- IEC/EN 60068-2-6
- IEEE 693
- IABG TA13-TM-002/98 (guide).

Climate and environmental influences

8DJH switchgear is completely enclosed and insensitive to climatic influences.

- The switchgear is maintenance-free under indoor ambient conditions (according to IEC 62271-1 and VDE 0671-1)
- Switchgear versions for outdoor installation or severe ambient conditions (according to customer specification) are available on request
- Climatic tests are fulfilled according to IEC/EN 62271-304/VDE 0671-304
- All medium-voltage devices (except for HV HRC fuses) are installed in a gas-tight, welded stainless-steel switchgear vessel which is filled with SF₆ gas
- Live parts outside the switchgear vessel are provided with single-pole enclosure
- At no point can creepage currents flow from high-voltage potentials to earth
- Operating mechanism parts which are functionally important are made of corrosion-resistant materials
- Bearings in the operating mechanism are designed as dry-type bearings and do not require lubrication.

Color of the panel front

Siemens standard (SN) 47030 G1, color no. 700/light basic (similar to RAL 7047/gray).

Protection against solid foreign objects, electric shock and water

8DJH switchgear fulfills according to the standards *)

IEC/EN 62271-1	VDE 0671-1
IEC/EN 62271-200	VDE 0671-200
IEC/EN 60529	DIN EN 60529

the following degrees of protection (for explanations, see opposite table):

Degree of protection	Type of protection
IP 2x	for switchgear enclosure
IP 3x	for switchgear enclosure (optional)
IP 65	for gas-filled switchgear vessel

IEC/EN 60529

Type of protection	Degree of protection
	IP 2 X
Protection against solid foreign objects	
Protected against solid foreign objects of 12.5 mm diameter and greater (the object probe, sphere of 12.5 mm diameter, shall not fully penetrate)	
Protection against access to hazardous parts	
Protected against access to hazardous parts with a finger (the jointed test finger of 12 mm diameter, 80 mm length, shall have adequate clearance from hazardous parts)	
Protection against water	
No definition	
	IP 3 X
Protection against solid foreign objects	
Protected against solid foreign objects of 2.5 mm diameter and greater (the object probe, sphere of 2.5 mm diameter, shall not penetrate at all)	
Protection against access to hazardous parts	
Protected against access to hazardous parts with a tool (the access probe, sphere of 2.5 mm diameter shall not penetrate)	
Protection against water	
No definition	
	IP 6 5
Protection against solid foreign objects	
Dust-tight (no ingress of dust)	
Protection against access to hazardous parts	
Protected against access to hazardous parts with a wire (the access probe of 1.0 mm diameter shall not penetrate)	
Protection against water	
Protected against water jets (water projected in jets against the enclosure from any direction shall have no harmful effects)	

*) For standards, see page 89

Published by and copyright © 2014:
Siemens AG
Wittelsbacherplatz 2
80333 Munich, Germany

Siemens AG
Infrastructure & Cities Sector
Low and Medium Voltage Division
Medium Voltage
Postfach 3240
91050 Erlangen, Germany
www.siemens.com/medium-voltage-switchgear
www.siemens.com/8DJH

All rights reserved.

If not stated otherwise on the individual pages of this catalog, we reserve the right to include modifications, especially regarding the stated values, dimensions and weights.

Drawings are not binding.

All product designations used are trademarks or product names of Siemens AG or other suppliers.

If not stated otherwise, all dimensions in this catalog are given in mm.

Subject to change without prior notice.

The information in this document contains general descriptions of the technical options available, which may not apply in all cases. The required technical options should therefore be specified in the contract.

For more information, please contact our
Customer Support Center.
Phone: +49 180 524 84 37
Fax: +49 180 524 24 71
(Charges depending on provider)
E-mail: support.ic@siemens.com

Order No. IC1000-K1440-A211-A5-7600

Printed in Germany

KG 04.14 3.0 92 En

7400/51952

Printed on elementary chlorine-free bleached paper.